

General Specifications

Electrical Capacity (Resistive Load)

Power Level: 6A @ 125V AC or 3A @ 250V AC

Other Ratings

Contact Resistance: 10 milliohms maximum
Insulation Resistance: 1,000 megohms minimum @ 500V DC
Dielectric Strength: 1,000V AC minimum between contacts for 1 minute minimum;
 1,500V AC minimum between contacts & case for 1 minute minimum
Mechanical Life: 50,000 operations minimum
Electrical Life: 25,000 operations minimum
Contact Timing: Nonshorting (break-before-make)
Total Travel: .087" (2.2mm)

Materials & Finishes

Actuator: Polyamide (UL94V-0)
Frame: Stainless steel
Case: Glass fiber reinforced diallyl phthalate resin (UL94V-0)
Movable Contacts: Silver alloy
Stationary Contacts: Silver capped copper with silver plating
Terminals: Copper or brass with silver plating

Environmental Data

Operating Temp Range: -10°C through +55°C (+14°F through +131°F)
Humidity: 90 ~ 95% humidity for 96 hours @ 40°C (104°F)
Vibration: 10 ~ 55Hz with peak-to-peak amplitude of 1.5mm traversing the frequency range & returning in 1 minute; 3 right angled directions for 2 hours
Shock: 50G (490m/s²) acceleration (tested in 6 right angled directions, with 5 shocks in each direction)

Processing

Soldering Time & Temp: Wave Soldering Recommended (PC version): See Profile A in Supplement section.
 Manual Soldering: See Profile A in Supplement section.
 Note: Lever must be in center position while soldering.
Cleaning: These devices are not process sealed. Hand clean locally using alcohol based solution.

Standards & Certifications

Flammability Standards: UL94V-0 rated actuator & case

Distinctive Characteristics

Bright, LED illumination at top of actuator.

Over-center actuator block and plunger design gives crisp actuation, diminishes sparking, and increases operating life.

Guide interlocked with actuator block prevents window locking and maintains correct plunger alignment to assure contact stability.

Antijamming design protects contacts from damage due to excessive downward force on the actuator.

High internal barriers between poles and insulating sheet between case and actuator block give added protection to contacts.

Prominent external insulating barriers increase insulation resistance and dielectric strength.

Epoxy sealed terminals prevent entry of flux, solvents, and other contaminants.

Clinching of frame to case well above base and terminals provides 1,500V dielectric strength.

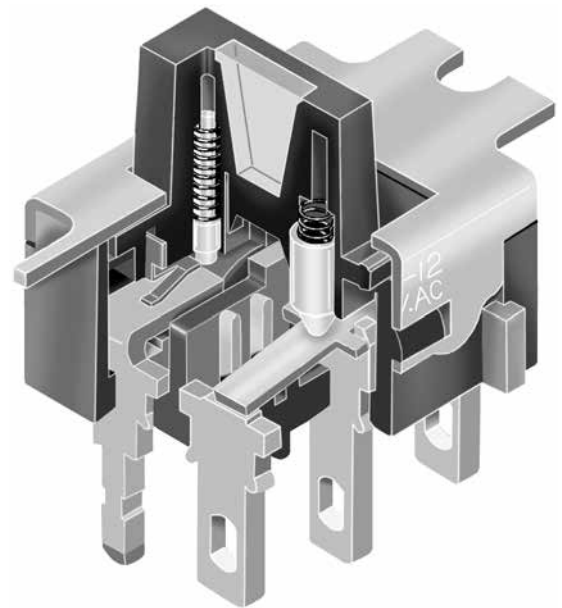

Actual Size

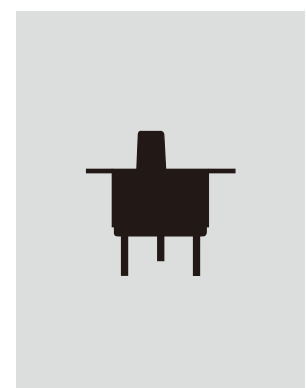

TYPICAL SWITCH ORDERING EXAMPLE

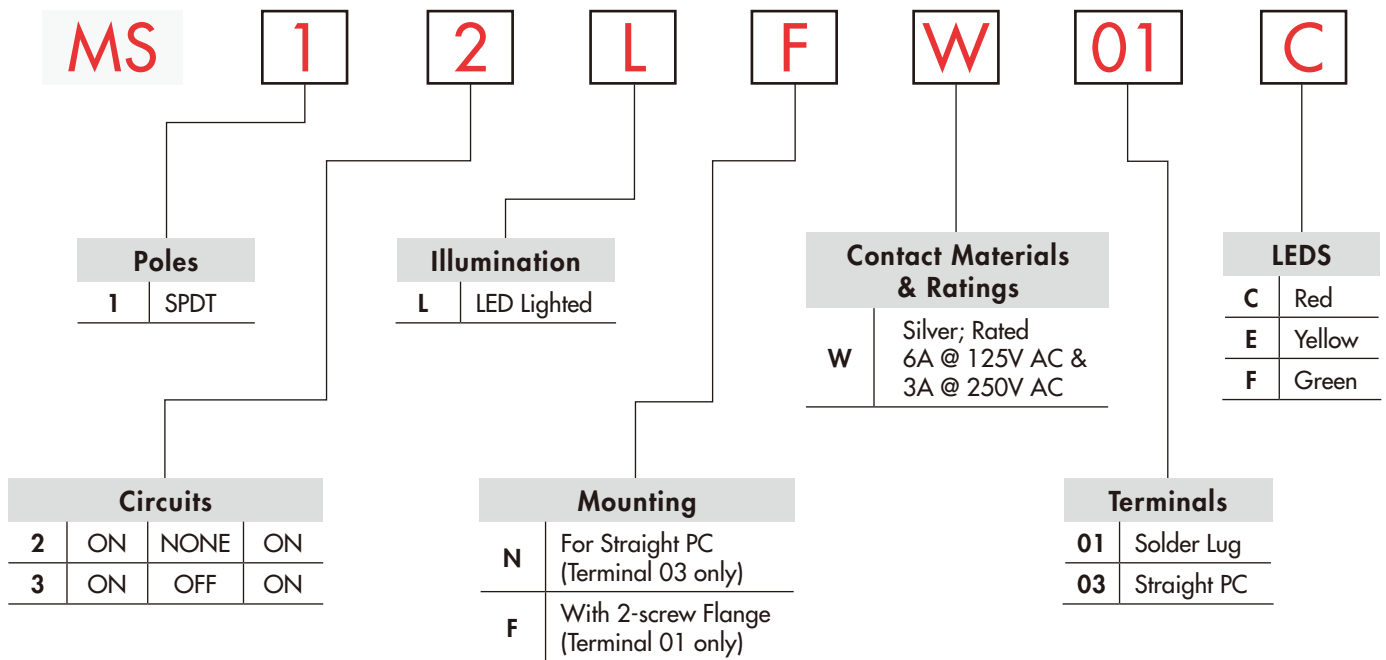

DESCRIPTION FOR TYPICAL ORDERING EXAMPLE

MS12LFW01C

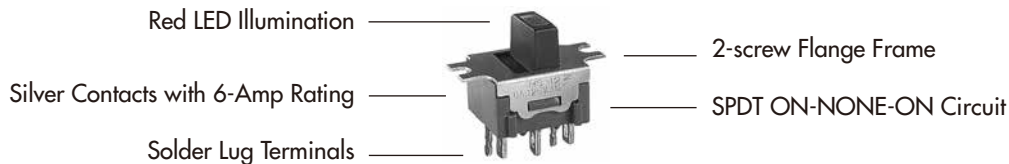

POLES & CIRCUITS

Pole	Model	Slide Position			Connected Terminals			Throw & Schematics
		Left	Center	Right	Left	Center	Right	
SP	MS12	ON	NONE	ON	2-1	OPEN	2-3	Note: Terminal numbers are not actually on the switch. LED circuit is isolated and requires an external connection.
	MS13	ON	OFF	ON				

CONTACT MATERIALS & RATINGS

W	Silver over Silver	Power Level	6A @ 125V AC & 3A @ 250V AC
----------	--------------------	-------------	-----------------------------

MOUNTING TYPES & TERMINALS

N Straight PC Mount
(Combines with Straight PC Terminal 03 only)



03 Straight PC

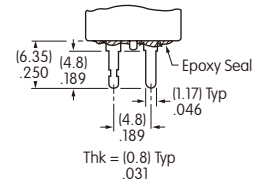

F 2-screw Flange
(Combines with Solder Lug Terminal 01 only)



01 Solder Lug

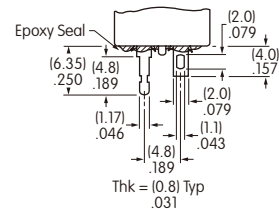

LED COLORS & SPECIFICATIONS

LEDs are supplied as an integral part of the switch (not available separately). The lamp circuit is independent of switch operation. Electrical specifications shown are determined at a basic temperature of 25°C. If the source voltage exceeds the rated voltage, a ballast resistor is required. The resistor value can be calculated by using the formula given in the Supplement.

		C Red	E Yellow	F Green
Maximum Forward Current	I_{FM}	30mA	30mA	25mA
Typical Forward Current	I_F	16mA	16mA	16mA
Forward Voltage	V_F	1.98V	2.06V	2.16V
Maximum Reverse Voltage	V_{RM}	5V	5V	5V
Current Reduction Rate Above 25°C	ΔI_F	0.40mA/°C	0.42mA/°C	0.33mA/°C
Ambient Temperature Range		-15° ~ +60°C		

TYPICAL SWITCH DIMENSIONS

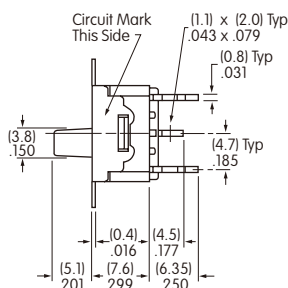
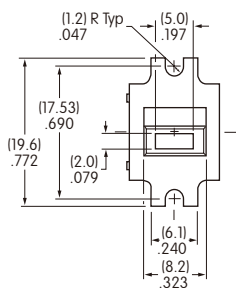

Actuator in LEFT Position

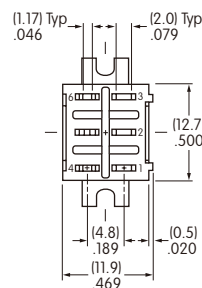

Maximum Panel Thickness .197" (5.0mm)

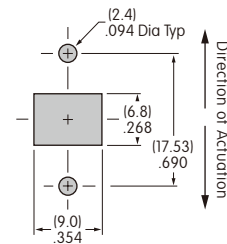

Solder Lug Terminals



MS12LFW01C

Straight PC Terminals

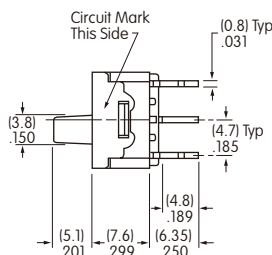
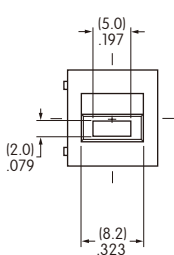

Actuator in LEFT Position

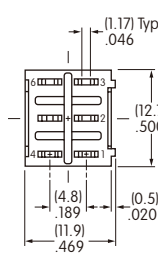

Maximum Panel Thickness .197" (5.0mm)

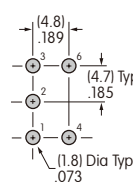

Direction of Actuation



MS12LNW03C