

General Specifications

Electrical Capacity (Resistive Load)

Low/Logic Level: 50mA @ 24V DC maximum for Standard Operating Force models
125mA @ 24V DC maximum for High Operating Force models

Other Ratings

	Standard Operating Force	High Operating Force
Contact Resistance:	50 milliohms maximum	50 milliohms maximum
Insulation Resistance:	500 megohms minimum @ 250V DC	500 megohms minimum @ 250V DC
Dielectric Strength:	250V AC minimum for 1 minute minimum	250V AC minimum for 1 minute minimum
Mechanical Life:	5,000,000 operations minimum	1,000,000 operations minimum
Electrical Life:	5,000,000 operations minimum	1,000,000 operations minimum
Nominal Operating Force:	1.76N for JB15	2.65N for JB15H
Total Travel:	.010" (.250mm)	.012" (.300mm)

Materials & Finishes

Actuator:	Glass fiber reinforced PBT for Extended actuator; PBT for Flat; Polyacetal for Short
Case:	Glass fiber reinforced polyamide (UL94V-0)
Seal:	Nitrile butadiene rubber
Base:	Glass fiber reinforced PBT (UL94V-0)
Movable Contacts:	Stainless steel
Stationary Contacts:	Brass with silver plating
Terminals:	Brass with silver plating
Mounting Bracket:	Phosphor bronze with tin plating

Environmental Data

Operating Temperature Range:	-25°C through +70°C (-13°F through +158°F)
Humidity:	90 ~ 95% humidity for 240 hours @ 40°C (104°F)
Vibration:	10 ~ 55Hz with peak-to-peak amplitude of 1.5mm traversing the frequency range & returning in 1 minute; 3 right angled directions for 2 hours
Shock:	50G (490m/s ²) acceleration (tested in 6 right angled directions, with 5 shocks in each direction)

PCB Processing

Soldering:	Wave Soldering Recommended. See Profile A in Supplement section. Manual Soldering: See Profile A in Supplement section.
Cleaning:	Automated cleaning. See Cleaning specifications in Supplement section.

Standards & Certifications

Flammability Standards:	UL94V-0 rated case & base The JB Series tactiles have not been tested for UL recognition or CSA certification. These switches are designed for use in a low-voltage, low-current, logic-level circuit. When used as intended in a logic-level circuit, the results do not produce hazardous energy.
--------------------------------	--

Distinctive Characteristics

Special bracket for right angle mounting provides added design variations.

Higher operating force type provides more pronounced operating feel.

Rubber seal construction prevents contact contamination and allows automated soldering and cleaning.

Choice of dimensions from PCB to top of cap allows design flexibility.

Dome contact gives crisp tactile feedback to positively indicate circuit transfer and assures high reliability and long life of up to 5,000,000 operations.

Slanted terminals provide a spring type action which ensures secure mounting and prevents dislodging during wave soldering.

Molded-in terminals are part of the sealed construction which allows automated soldering and washing.

Terminal spacing conforms to standard .100" (2.54mm) PCB grid.

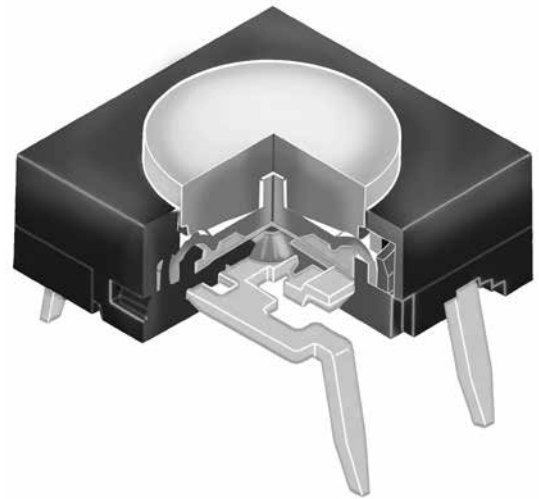

Actual Size



Common Bus Matrix

These single pole, single throw switches can be used in a keyboard matrix and, using strapped terminals, achieve a common bus electrical configuration on a single-sided PC board.

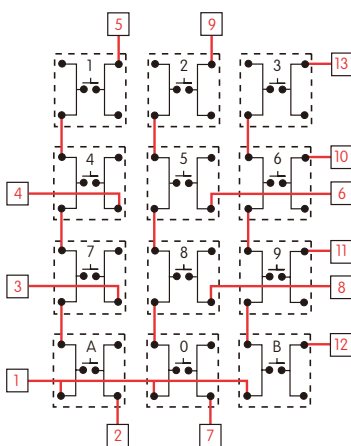

		PC Terminations												
		1	2	3	4	5	6	7	8	9	10	11	12	13
Keys (Switches)	1	○				●								
	2	○									●			
	3	○												●
	4	○												
	5	○				●								
	6	○												
	7	○												
	8	○												
	9	○												
	0	○												
	A	○												
	B	○												

○ = OFF ● = ON

X-Y Matrix

These single pole, single throw switches can be arranged on a single-sided PC board matrix with strapped terminals to achieve an X-Y type electrical interconnection.

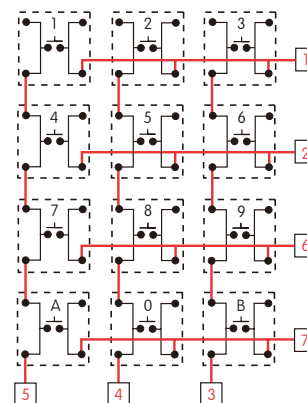

		PC Terminations						
		1	2	3	4	5	6	7
Keys (Switches)	1	○						
	2	○	●					
	3	○		●				
	4	○			●			
	5	○				●		
	6	○					●	
	7	○						●
	8	○						
9	○							
0	○							
A	○							
B	○							

○ = OFF ● = ON

Red = PCB Trace Black = Switch Circuit

Toggles
Rockers
Pushbuttons
Illuminated PB
Programmable
Keylocks
Rotaries
Slides
Tactiles
Tilt
Touch
Indicators
Accessories
Supplement

TYPICAL SWITCH ORDERING EXAMPLE

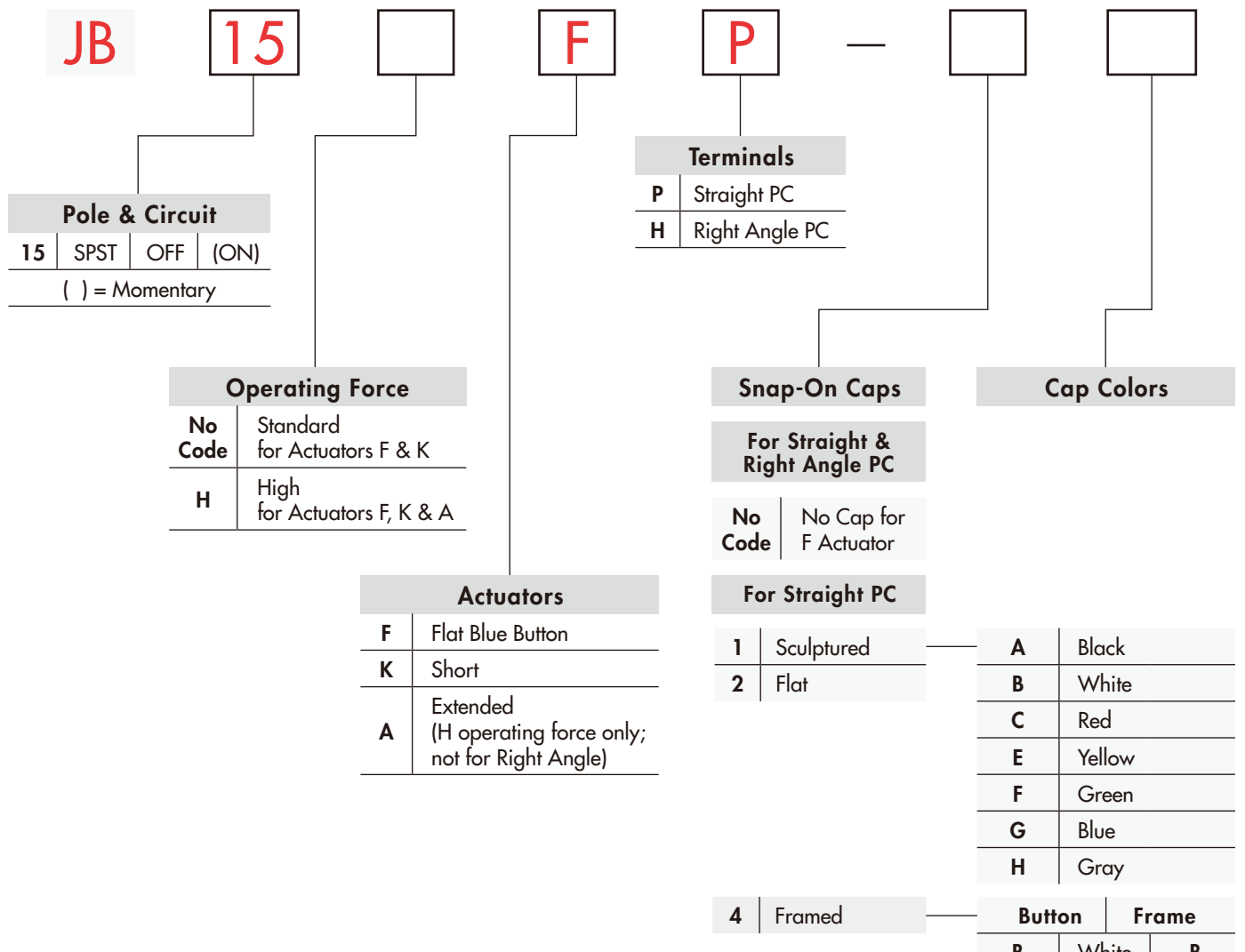

DESCRIPTION FOR TYPICAL ORDERING EXAMPLE

JB15FP

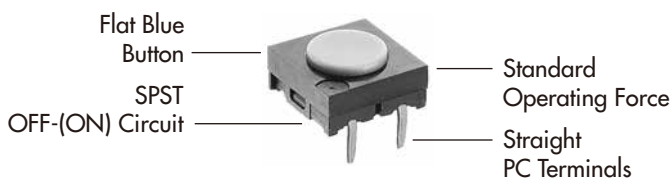

5 Cap with Black Mounter

A	Black
B	White
C	Red
H	Gray

For Right Angle PC

6 Flat

A	Black
B	White
C	Red
H	Gray

POLE & CIRCUIT

		Actuator Position () = Momentary		Switch Throw & Schematic	Note: Terminal numbers are shown on the switch.
Pole	Model	Normal	Down		
SP	JB15	OFF	(ON)	SPST	

OPERATING FORCE

No Code

Standard Operating Force

1.76N

For F & K Actuators

H

High Operating Force

2.65N

For F, K & A Actuators

ACTUATORS

F

Flat Blue Button

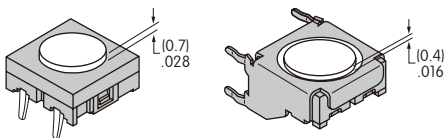

Flat button is an integral part of the switch and cannot be ordered separately.

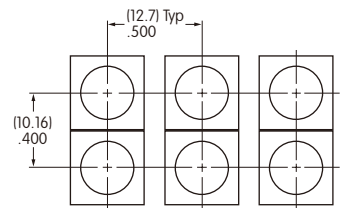
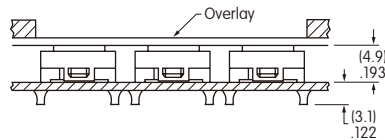

Custom keyboards can be designed with flat buttons beneath an overlay. Not applicable for right angle mounting.

K

Short Actuator

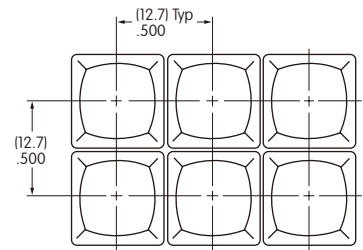
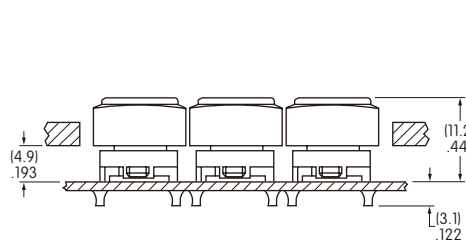
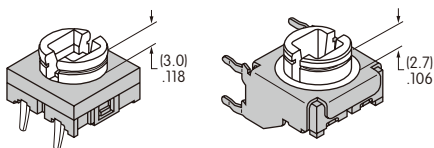

Custom keyboards can be designed with caps installed through a panel cutout (illustration with framed cap AT4078 and button AT4077). Not applicable for right angle mounting.

A

Extended Actuator

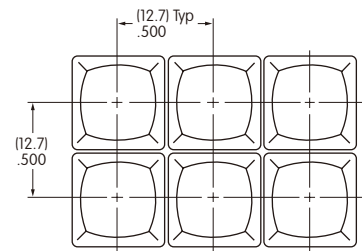
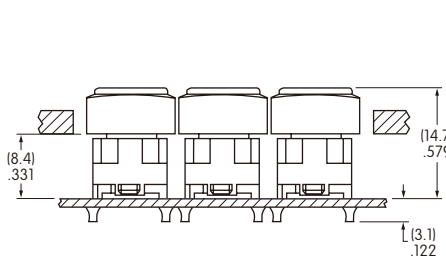
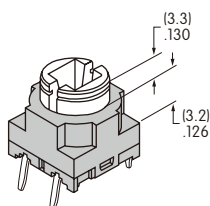

Combines with high operating force only; not for right angle.

Custom keyboards can be designed with caps installed through a panel cutout (illustration with framed cap AT4078 and button AT4077).

Toggle
Rockers
Pushbuttons
Illuminated PB
Programmable
Keylocks
Rotaries
Slides
Tactiles
Tilt
Touch
Indicators
Accessories
Supplement

TERMINALS

P Straight PC

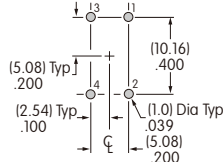
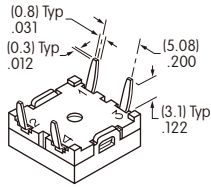

H Right Angle PC

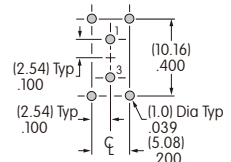
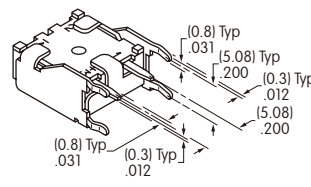

Further details shown in Typical Switch Dimensions

SNAP-ON CAPS

1 AT4058 Sculptured for Straight PC

Material: Polyamide
Finish: Matte
Colors: A B C E F G H

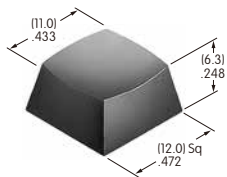

2 AT4059 Flat for Straight PC

Material: Polycarbonate
Finish: Glossy
Colors: A B C E F G H

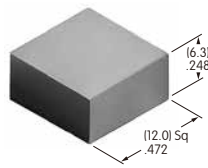

4 Framed: AT4077 Button & AT4078 Frame for Straight PC

Material: Polycarbonate
Finish: Matte
Colors: B C E F G H

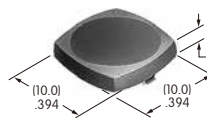

6 AT4139 Flat for Right Angle PC

Material: Polycarbonate
Finish: Glossy
Colors: A B C H

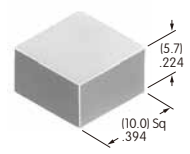

5 AT4140 Cap with AT547 Mounter for Straight PC

Cap
Material: Polycarbonate
Finish: Glossy
Colors: A B C H



Mounter
Material: Polyamide
Finish: Matte
Color: A

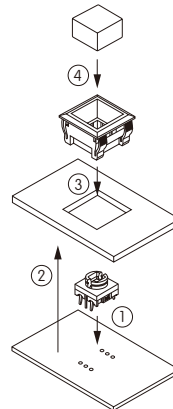

Assembly Procedure

1. Solder switch to PCB.
2. Install PCB in equipment.
3. Snap mounter into panel. Dimension from top of panel to top of PCB is .386" (9.8mm).
4. Snap cap onto plunger.

Panel Cutout & Footprint

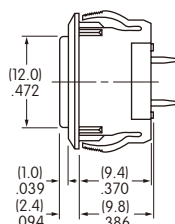
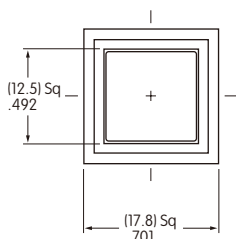

Panel Mounting Dimensions

Panel Thickness:
.039" ~ .079"
(1.0mm ~ 2.0mm)

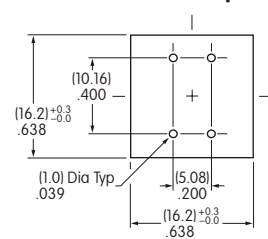

Cap Colors Available:

A Black

B White

C Red

E Yellow

F Green

G Blue

H Gray

TYPICAL SWITCH DIMENSIONS

Flat Blue Button • Straight PC

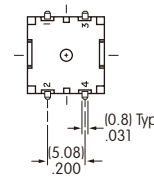
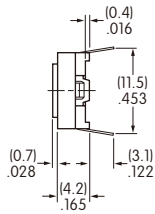
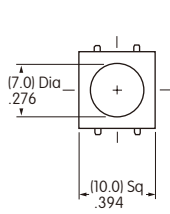

Spring action terminals conform to .100" (2.54mm) PCB spacing

JB15FP

Flat Blue Button • Right Angle PC

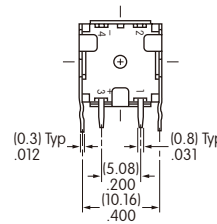
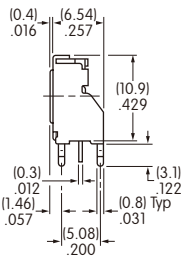
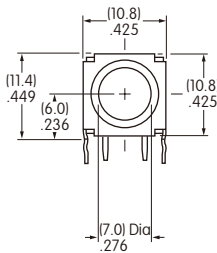

JB15FH

Short Actuator

Extended Actuator

Sculptured Snap-on Cap • Straight PC

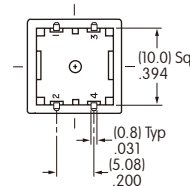
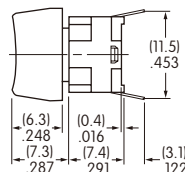
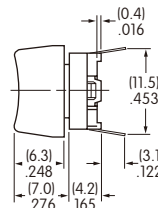
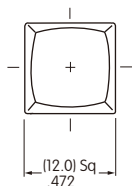

Spring action terminals conform to .100" (2.54mm) PCB spacing

JB15KP-1C

Short Actuator

Extended Actuator

Flat Snap-on Cap • Straight PC

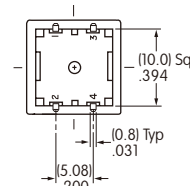
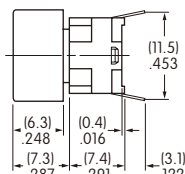
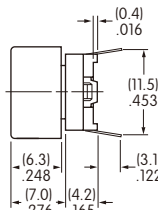
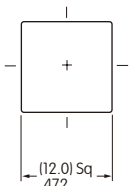

Spring action terminals conform to .100" (2.54mm) PCB spacing

JB15KP-2C

Short Actuator

Extended Actuator

Framed Snap-on Cap • Straight PC

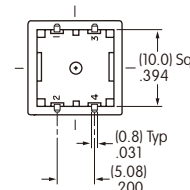
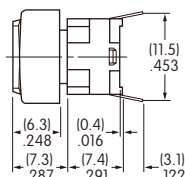
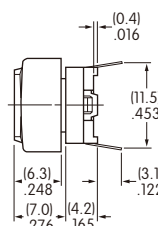
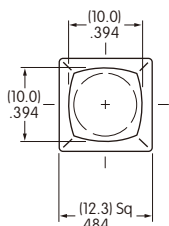

Spring action terminals conform to .100" (2.54mm) PCB spacing

JB15FHAP-4BC

TYPICAL SWITCH DIMENSIONS

Flat Snap-on Cap • Right Angle PC



JB15KH-6C

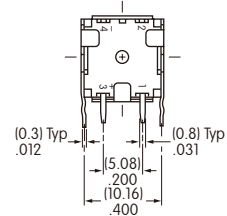
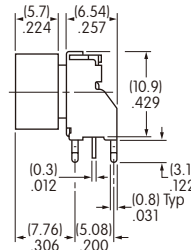
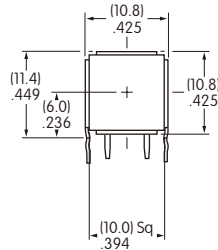

LEGENDS

NKK Switches can provide custom legends for caps. Contact factory for more information.

Shaded Areas are Printable Areas

AT4058



AT4059 & AT4140

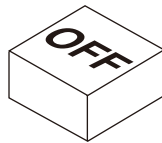

AT4077 Button

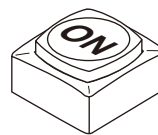

AT4139

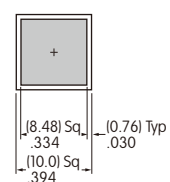
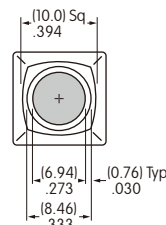
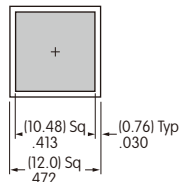
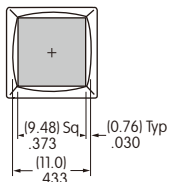
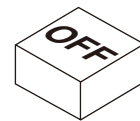

Recommended Print Method: Screen Print or Pad Print. Epoxy based ink is recommended.

