

## Contents for Standard Size Toggles



### Low Capacity ..... Page A101

5A Power Level  
Solder Lug Terminals  
Bushing Mount  
Double Pole



### Medium Capacity ..... Page A103

15~20A Power Level  
Solder Lug, Quick Connect Terminals  
Bushing Mount  
Single & Double Pole



### Medium/High Capacity .... Page A108

15~25A Power Level  
Solder Lug, Screw Lug, Quick Connect Terminals  
Bushing Mount  
One through Four Pole



### High Capacity ..... Page A119

30~50A Power Level  
Screw Lug Terminals  
Bushing Mount or Mounting Screws  
Double Pole & Three Pole

GENERAL SPECIFICATIONS FOR S1 ~ S29

A Toggles  
 Rockers  
 Pushbuttons  
 Illuminated PB  
 Programmable  
 Keylocks  
 Rotaries  
 Slides  
 Tactiles  
 Tilt  
 Touch  
 Indicators  
 Accessories  
 Supplement

**Electrical Capacity (Resistive & Inductive Load)**

**Power Level:** Shown in the following tables

**Other Ratings**

- Contact Resistance:** 10 milliohms maximum
- Insulation Resistance:** 1,000 megohms minimum @ 500V DC
- Dielectric Strength:** 2,000V AC minimum for 1 minute minimum
- Mechanical Life:** 30,000 operations minimum for S5AW, S8AW, S9AW, S25AW, S28AW, S29AW  
50,000 operations minimum for all other models
- Electrical Life:** 25,000 operations minimum
- Angle of Throw ( $\alpha$ ):** Shown in tables on following pages

**Materials & Finishes**

- Toggle:** Brass with chrome plating
- Bushing:** Brass with chrome plating
- Case:** Phenolic resin
- Case Cover:** Steel with zinc plating
- Movable Contactor:** Copper with silver plating
- Movable Contacts:** Silver alloy capped on copper with silver plating
- Stationary Contacts:** Silver alloy capped on copper with silver plating
- Terminals:** Brass with tin plating

**Environmental Data**

- Operating Temp Range:** -30°C through +70°C (-22°F through +158°F) for Splashproof models;  
-10°C through +70°C (+14°F through +158°F) for all other models
- Sealing:** Splashproof & lever lock panel seal models meet IP67 standard

**Installation**



- Mounting Torque:** 1.47Nm (13 lb•in) for single nut on AW & AL models  
2.94Nm (26 lb•in) for double nut on other models
- Maximum Panel Thickness:** Shown beneath panel cutout in switch dimension drawings
- Soldering Time & Temperature:** Manual Soldering: See Profile A in Supplement section.

**Standards & Certifications**

- UL:** **File No. E44145 - Recognized only when ordered with marking on switch.**  
Add "/U" or "/CUL" to end of part number to order UL recognized switch.  
UL or cULus recognition designated beside part numbers on following pages.  
See Supplement section to find UL or cULus rating details.
- CSA:** **File No. 023535\_0\_000 - Certified only when ordered with marking on switch.**  
Add "/C" to end of part number to order CSA certified switch.  
CSA certification designated beside part numbers on following pages.  
See Supplement section to find CSA rating details.

Toggles A  
 Rockers  
 Pushbuttons  
 Illuminated PB  
 Programmable  
 Keylocks  
 Rotaries  
 Slides  
 Tactiles  
 Tilt  
 Touch  
 Indicators  
 Accessories  
 Supplement

### SINGLE POLE WITH SOLDER LUG

* UL, cULus & CSA recognized only when ordered with marking on switch (see General Specs)			Toggle Position/Connected Terminals			Electrical Capacity				Angle of Throw		
Model	* Approvals			Pole & Throw	Down 	Center 	Up 	Resistive			Inductive	
	UL	cULus	CSA					AC 125V	AC 250V		DC 30V	AC 125V PF 0.6
S1A	✓	✓	✓	SPST	ON 1-3	NONE	OFF —	15A	6A	20A	8A	25°
S2A	✓	✓	✓	SPDT	ON 2-3	NONE	ON 2-1	15A	6A	20A	8A	25°
S3A	✓	✓	✓	SPDT	ON 2-3	OFF	ON 2-1	15A	6A	20A	8A	25°

**Throw & Schematics:**

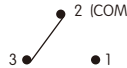

SPST  INTERNAL CONNECTION 

Note: Terminal numbers are actually on the switch

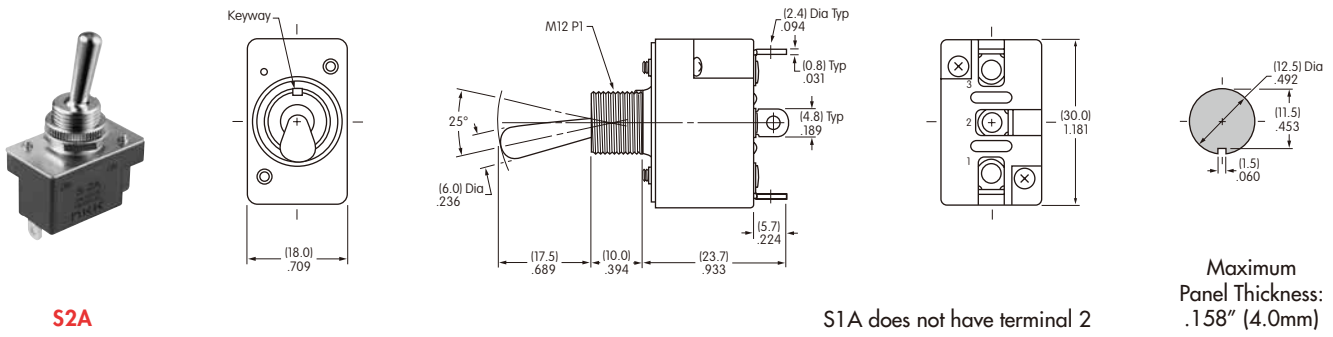

**Notes:** Standard Hardware: AT504M Knurled Nut, AT508 Lockwasher, AT527M Backup Hex Nut. See Accessories & Hardware section.  
 Optional Splashproof Boot Assemblies: AT401 & AT4181 boots plus hex nut & o-ring. See Accessories & Hardware section.



### DOUBLE POLE WITH SOLDER LUG

* UL, cULus & CSA recognized only when ordered with marking on switch (see General Specs)			Toggle Position/Connected Terminals			Electrical Capacity				$\alpha =$ Angle of Throw		
Model	* Approvals			Pole & Throw	Down 	Center 	Up 	Resistive			Inductive	
	UL	cULus	CSA					AC 125V	AC 250V		DC 30V	AC 125V PF 0.6
S21A	—	—	—	DPST	ON 1-3 4-6	NONE	OFF —	15A	15A	15A	8A	21°
S6A	✓	✓	✓	DPDT	ON 2-3 5-6	NONE	ON 2-1 5-4	20A	10A	20A	8A	21°
S7A	—	—	✓	DPDT	ON 2-3 5-6	OFF	ON 2-1 5-4	20A	10A	20A	8A	28°

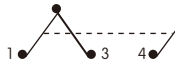
**Throw & Schematics:**



DPST  INTERNAL CONNECTION 

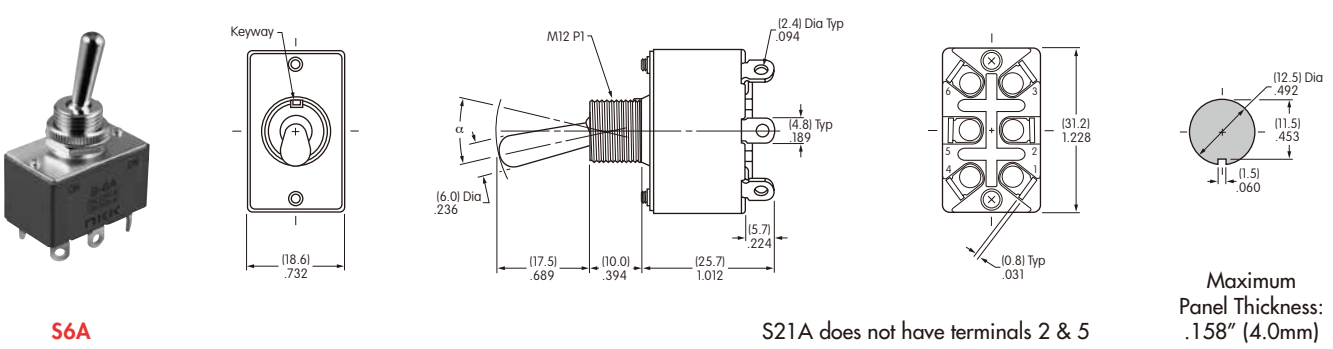

Note: Terminal numbers are actually on the switch

**Notes:** Standard Hardware: AT504M Knurled Nut, AT508 Lockwasher, AT527M Backup Hex Nut. See Accessories & Hardware section.  
 Optional Splashproof Boot Assemblies: AT401 & AT4181 boots plus hex nut & o-ring. See Accessories & Hardware section.



## SINGLE POLE WITH QUICK CONNECT



Model	Approvals		Pole & Throw	Toggle Position/Connected Terminals			Electrical Capacity				Angle of Throw
	UL	SE		Down 	Center 	Up 	Resistive			Inductive	
							AC 125V	AC 250V	DC 30V	AC 125V PF 0.6	
S1F	—	—	SPST	ON 1-3	NONE	OFF —	15A	6A	20A	8A	25°
S2F	—	—	SPDT	ON 2-3	NONE	ON 2-1	15A	6A	20A	8A	25°
S3F	—	—	SPDT	ON 2-3	OFF	ON 2-1	15A	6A	20A	8A	25°

**Throw & Schematics:** SPST  INTERNAL CONNECTION  Note: Terminal numbers are actually on the switch

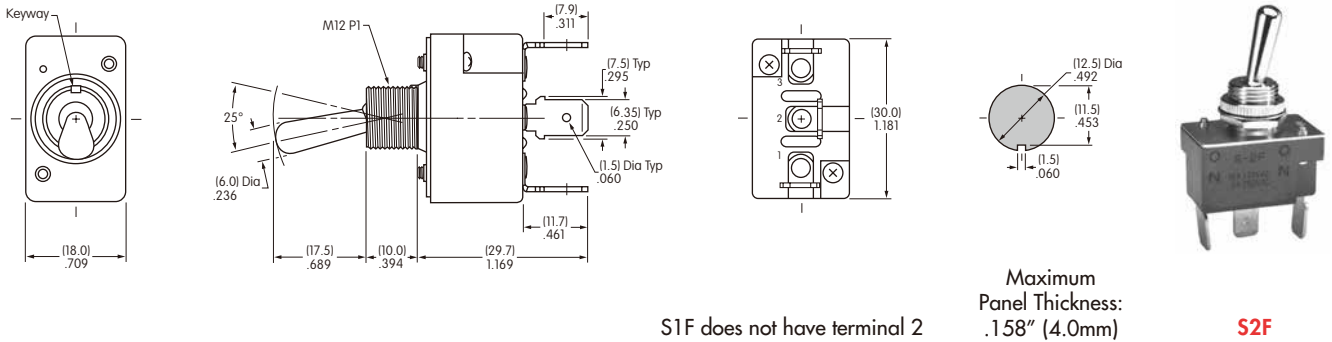
**Notes:** Standard Hardware: AT504M Knurled Nut, AT508 Lockwasher, AT527M Backup Hex Nut. See Accessories & Hardware section.  
Optional Splashproof Boot Assemblies: AT401 & AT4181 boots plus hex nut & o-ring. See Accessories & Hardware section.



## DOUBLE POLE WITH QUICK CONNECT

Model	Approvals		Pole & Throw	Toggle Position/Connected Terminals			Electrical Capacity				$\alpha$ = Angle of Throw
	UL	SE		Down 	Center 	Up 	Resistive			Inductive	
							AC 125V	AC 250V	DC 30V	AC 125V PF 0.6	
S21F	—	—	DPST	ON 1-3 4-6	NONE	OFF —	15A	15A	15A	8A	21°
S6F	—	—	DPDT	ON 2-3 5-6	NONE	ON 2-1 5-4	20A	10A	20A	8A	21°
S7F	—	—	DPDT	ON 2-3 5-6	OFF	ON 2-1 5-4	20A	10A	20A	8A	28°

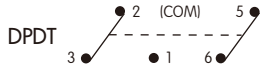

**Throw & Schematics:** DPST  INTERNAL CONNECTION  Note: Terminal numbers are actually on the switch

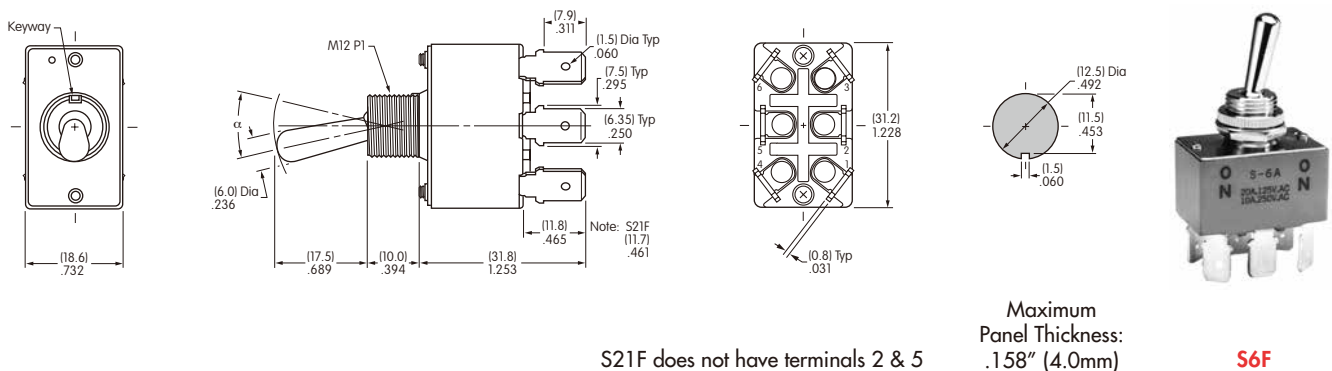

**Notes:** Standard Hardware: AT504M Knurled Nut, AT508 Lockwasher, AT527M Backup Hex Nut. See Accessories & Hardware section.  
Optional Splashproof Boot Assemblies: AT401 & AT4181 boots plus hex nut & o-ring. See Accessories & Hardware section.



Toggles A  
 Rockers  
 Pushbuttons  
 Illuminated PB  
 Programmable  
 Keylocks  
 Rotaries  
 Slides  
 Tactiles  
 Tilt  
 Touch  
 Indicators  
 Accessories  
 Supplement

### SINGLE POLE SOLDER LUG WITH PANEL SEAL

Model	Approvals UL SP	Pole & Throw	Toggle Position/Connected Terminals ( ) = Momentary				Electrical Capacity			$\alpha$ = Angle of Throw
			Down 	Center 	Up 	Resistive				
						AC 125V	AC 250V	DC 30V		
S1AW	—	SPST	ON 1-3	NONE	OFF —	15A	6A	20A	24°	
S2AW	—	SPDT	ON 2-3	NONE	ON 2-1	15A	6A	20A	24°	
S3AW	—	SPDT	ON 2-3	OFF	ON 2-1	15A	6A	20A	28°	
S5AW	—	SPDT	ON 2-3	NONE	(ON) 2-1	15A	6A	20A	20°	
S8AW	—	SPDT	(ON) 2-3	OFF	(ON) 2-1	15A	6A	20A	24°	
S9AW	—	SPDT	ON 2-3	OFF	(ON) 2-1	15A	6A	20A	24°	

**Throw & Schematics:** SPST  INTERNAL CONNECTION  Note: Terminal numbers are actually on the switch

**Notes:** Standard Hardware: AT503M Face Hex Nut, AT508 Lockwasher, AT537 O-ring. See Accessories & Hardware section. For .250" Quick Connect terminals, add "F" to end of part number. See Quick Connect terminal dimensions on previous page. For further information, contact factory.



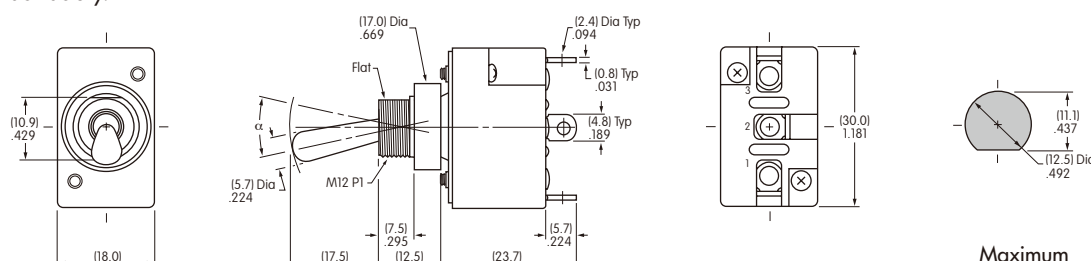

S2AW





S1AW does not have terminal 2

Maximum Panel Thickness: .158" (4.0mm)

### DOUBLE POLE SOLDER LUG WITH PANEL SEAL

Model	Approvals UL SP	Pole & Throw	Toggle Position/Connected Terminals ( ) = Momentary				Electrical Capacity			$\alpha$ = Angle of Throw
			Down 	Center 	Up 	Resistive				
						AC 125V	AC 250V	DC 30V		
S21AW	—	DPST	ON 1-3 4-6	NONE	OFF —	15A	15A	15A	22°	
S6AW	—	DPDT	ON 2-3 5-6	NONE	ON 2-1 5-4	20A	10A	20A	22°	
S7AW	—	DPDT	ON 2-3 5-6	OFF	ON 2-1 5-4	20A	10A	20A	28°	
S25AW	—	DPDT	ON 2-3 5-6	NONE	(ON) 2-1 5-4	15A	6A	20A	20°	
S28AW	—	DPDT	(ON) 2-3 5-6	OFF	(ON) 2-1 5-4	15A	6A	20A	22°	
S29AW	—	DPDT	ON 2-3 5-6	OFF	(ON) 2-1 5-4	15A	6A	20A	22°	

**Throw & Schematics:** DPST  INTERNAL CONNECTION  Note: Terminal numbers are actually on the switch

**Notes:** Standard Hardware: AT503M Face Hex Nut, AT508 Lockwasher, AT537 O-ring. See Accessories & Hardware section. For .250" Quick Connect terminals, add "F" to end of part number. See Quick Connect terminal dimensions on previous page. For further information, contact factory.



S6AW

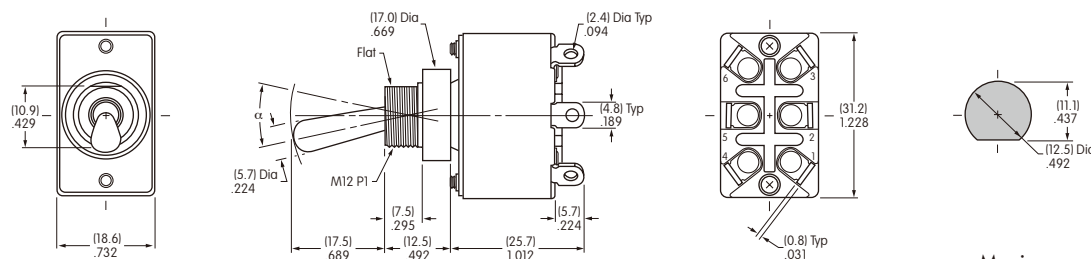

S21AW does not have terminals 2 & 5

Maximum Panel Thickness: .158" (4.0mm)

## SINGLE POLE SOLDER LUG WITH LOCKING LEVER & PANEL SEAL

Model	Approvals 	Pole & Throw	Toggle Position/Connected Terminals			Electrical Capacity				$\alpha$ = Angle of Throw
			Down 	Center 	Up 	Resistive			Inductive	
						AC 125V	AC 250V	DC 30V	AC 125V PF 0.6	
S1AL	— —	SPST	ON 1-3	NONE	OFF —	15A	6A	20A	8A	24°
S2AL	— —	SPDT	ON 2-3	NONE	ON 2-1	15A	6A	20A	8A	24°
S3AL	— —	SPDT	ON 2-3	OFF	ON 2-1	15A	6A	20A	8A	28°

**Throw & Schematics:**

SPST:

SPDT:

Note: Terminal numbers are actually on the switch

Notes: Standard Hardware: AT503M Face Hex Nut, AT508 Lockwasher, AT537 O-ring. See Accessories & Hardware section.

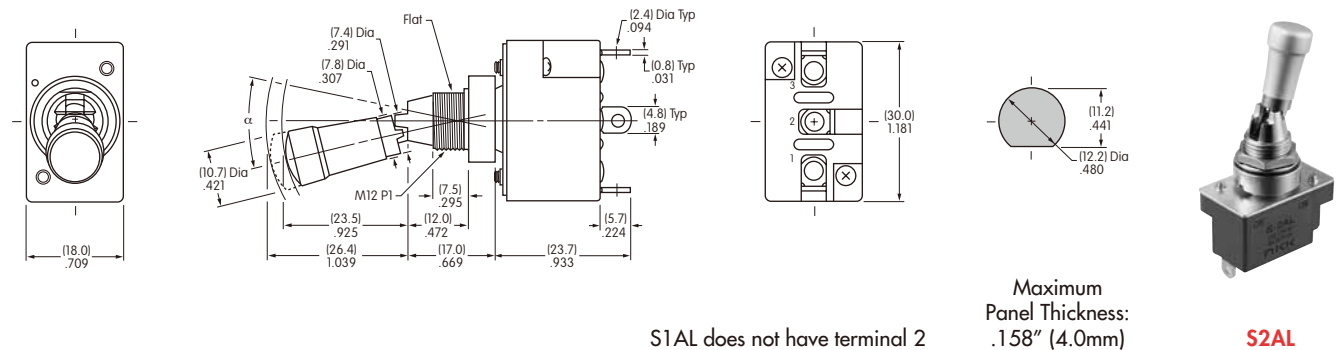

## DOUBLE POLE SOLDER LUG WITH LOCKING LEVER & PANEL SEAL

Model	* Approvals 	Pole & Throw	Toggle Position/Connected Terminals			Electrical Capacity				$\alpha$ = Angle of Throw
			Down 	Center 	Up 	Resistive			Inductive	
						AC 125V	AC 250V	DC 30V	AC 125V PF 0.6	
S21AL	— —	DPST	ON 1-3 4-6	NONE	OFF —	15A	15A	15A	8A	22°
S6AL	✓ ✓	DPDT	ON 2-3 5-6	NONE	ON 2-1 5-4	20A	10A	20A	8A	22°
S7AL	— —	DPDT	ON 2-3 5-6	OFF	ON 2-1 5-4	20A	10A	20A	8A	28°

**Throw & Schematics:**

DPST:

DPDT:

Note: Terminal numbers are actually on the switch

Notes: Standard Hardware: AT503M Face Hex Nut, AT508 Lockwasher, AT537 O-ring. See Accessories & Hardware section.

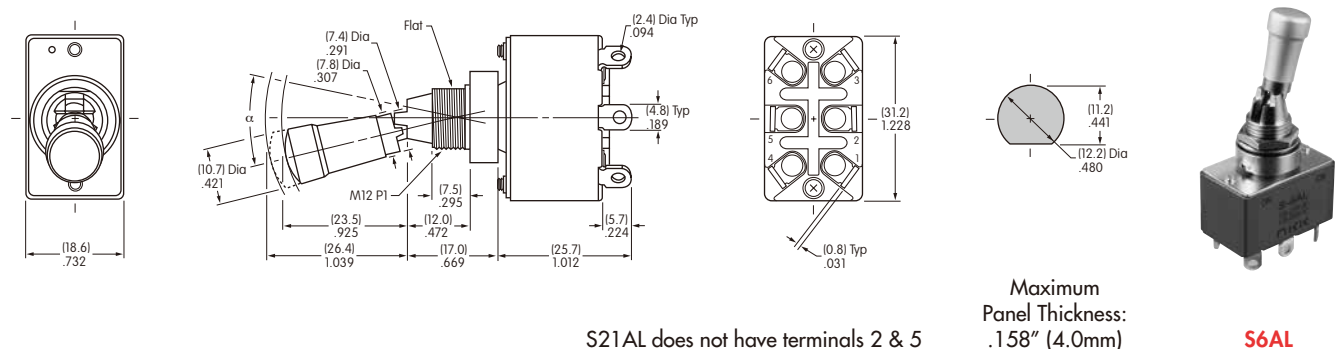

Toggles  
Rockers  
Pushbuttons  
Illuminated PB  
Programmable  
Keylocks  
Rotaries  
Slides  
Tactiles  
Tilt  
Touch  
Indicators  
Accessories  
Supplement