

Resistive Touch Screens

5-Wire, 4-Wire & Digital Solutions

NKK's transparent touch screens are engineered to complement the application of choice while offering superior durability and flexibility. With options in multiple sizes, and choices of input by finger, gloved finger or stylus, we maintain a consistent focus on impeccable quality and value added solutions with the diverse needs of our customers at the forefront.

Whether an application requires the 5- or 4-wire technology, the features include metal tails (analog), contact reliability with a connector, and ANR film, eliminating many of the typical visual artifacts. The film surface is non-glare and hard coated for ease of use and integrity of the surface.

Additional benefits of NKK's 5-wire touch screens include:

- Screens highly resistant to static electricity and noise pollution
- Drift-free operation despite any temperature fluctuation
- Greater touch point density translating to more precision and reduction of false actuations
- Quicker response time

DISTINCTIVE CHARACTERISTICS

- Wide Range of Available Sizes
- Custom Solutions a Specialty
- Digital and Analog Solutions
- Controllers Available
- Anti-Newton Ring (ANR) Technology for Analog Touch Screens
- Design Minimizes Visual Artifacts
- RoHS Compliant

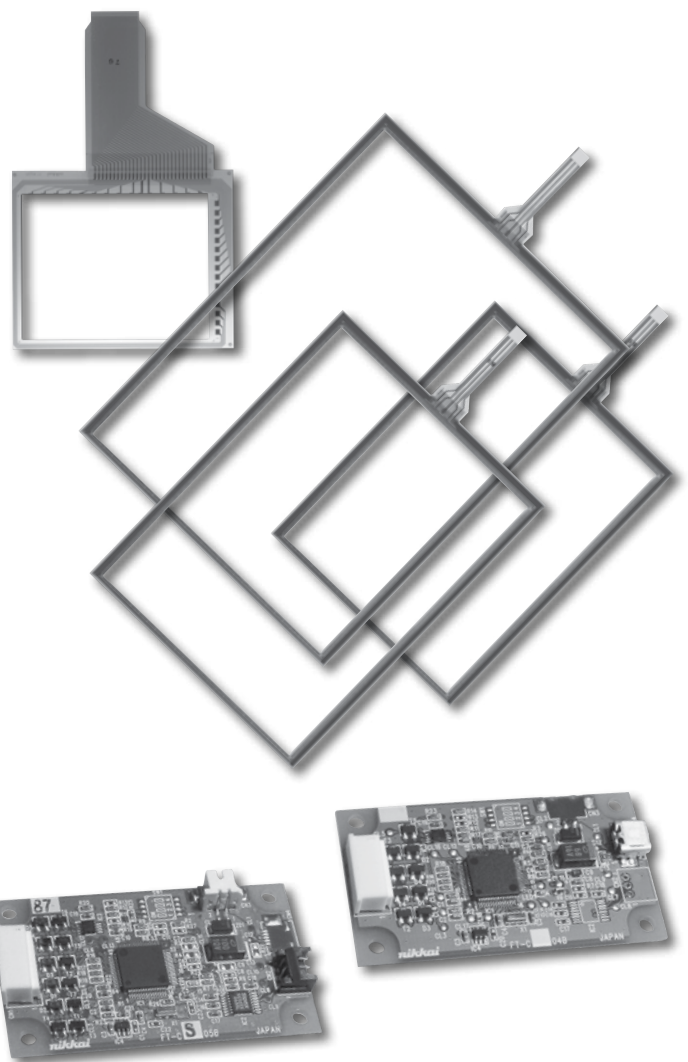

APPLICATIONS

- Information Kiosks
- Industrial Automation
- Banking, Exchange Management Systems
- Broadcast
- Office Automation
- Medical Equipment
- Hand-held Devices
- Hospitality and Restaurant
- Gaming

Customization Options

Parameter	Notes & Options
Resistive Analog Touch Screen	4-Wire or 5-Wire
Integrate LCD & Touchscreen	Yes - No
5-Wire - Screen Size Diagonal Inches	Standard 10.4, 12.1, 15 (min 10.4, max 19)
4-Wire - Screen Size Diagonal Inches	Standard 5.7, 6.5, 8.4, 10.4, 10.6, 12.1, 15, 15.6, 19
Data Entry Area mm x mm	Same as the dimensions of the display area of the LCD
Viewable Area mm x mm	Same as the dimensions of the bezel opening of the LCD
Perimeter Dimensions mm x mm	
Tail Type	2 standard options: PCB or FPC
Tail Pitch	PCB: 1.25mm / FPC: 1.0mm
Tail Pins	PCB: 8 pins / FPC: 4 pins
Tail Length	2 standard options: 65mm or 80mm
Tail Base Width	PCB: 28.2mm / FPC: 15.0mm
Tail Location	10.4 is left and top / Other sizes are left
Tail Material	PCB: Carbon-coated silver is standard, option is copper-gold FPC: Polyimide resin from PET
Glass Thickness	1.1 and 1.8mm are standard (note: total thickness = glass thickness + 0.3mm)
Hardcoat Treatment	Standard
Anti-Newton Ring Treatment	Standard
Optical Transmission Factor	80% is standard
Controller	Yes - No (no = customer will supply)
Communication	USB or RS232C
Operating System	Windows 7, 8 and 10 Compatible

Toggles
Rockers
Pushbuttons
Illuminated PB
Programmable
Keylocks
Rotaries
Slides
Tactiles
Tilt
Touch
Indicators
Accessories
Supplement

General Specifications

5-Wire Resistive Analog Touch Screens

Optical	
Light Transmission	80% standard
Film Options	Anti-glare, anti-Newton ring standard
Electrical	
Power Level	5.5V DC
X Y Resistive Value	20 ~ 80Ω
Insulation Impedance	10MΩ minimum @ 25V DC
Linearity	±2% maximum (after adjustment made by control board or device driver)
Chattering Time	10 milliseconds maximum
Mechanical	
Touch Activation Force	1.47N
Available Sizes	10.4", 12.1" and 15.0"
Durability	
Surface Hardness	2H (JIS K5600)
Expected Operational Life	Writing: 50,000 minimum operations (approximately 30mm movement with stylus)
	Tapping: 10,000,000 operations minimum (using silicon rubber)
Environmental	
Operating Temperature Range	-20°C ~ +70°C (-4°F ~ +158°F)
Storage Temperature Range	-40°C ~ +80°C (-22°F ~ +158°F)
Relative Humidity	+60°C (+140°F), humidity 90%, 240 hours

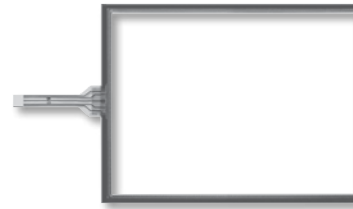

FTAS00-10.4A-5

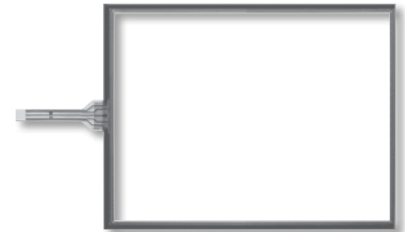

FTAS00-12.1A-5



FTAS00-15A-5

PART NUMBERS & DESCRIPTIONS FOR 5-WIRE

5-Wire Analog Touch Screens						
Part Number	Screen Size in Inches	Key Area Dimensions	Viewing Area Dimensions	External Dimensions	Panel Thickness	Terminal Detail 8 Pin .049" (1.25mm) Pitch
FTAS00-10.4A-5	10.4	8.5" x 6.45" (215.9mm x 163.9mm)	8.66" x 6.61" (219.9mm x 167.9mm)	9.31" x 7.22" (236.5mm x 183.3mm)	.083" (2.1mm)	Length 3.15" (80.0mm)
FTAS00-12.1A-5	12.1	9.8" x 7.37" (249.0mm x 187.2mm)	9.94" x 7.50" (252.4mm x 190.6mm)	10.52" x 8.1" (267.1mm x 205.8mm)	.083" (2.1mm)	Length 3.15" (80.0mm)
FTAS00-15A-5	15.0	12.05" x 9.06" (306.1mm x 230.1mm)	12.19" x 9.19" (309.5mm x 233.5mm)	12.79" x 9.79" (324.8mm x 248.7mm)	.083" (2.1mm)	Length 3.15" (80.0mm)

Note: See web site for dimensioned drawings for all 5-Wire Analog Touch Screens.

GENERAL SPECIFICATIONS FOR 5-WIRE

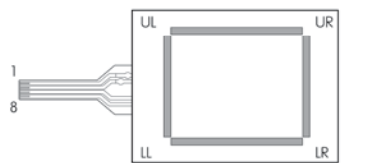
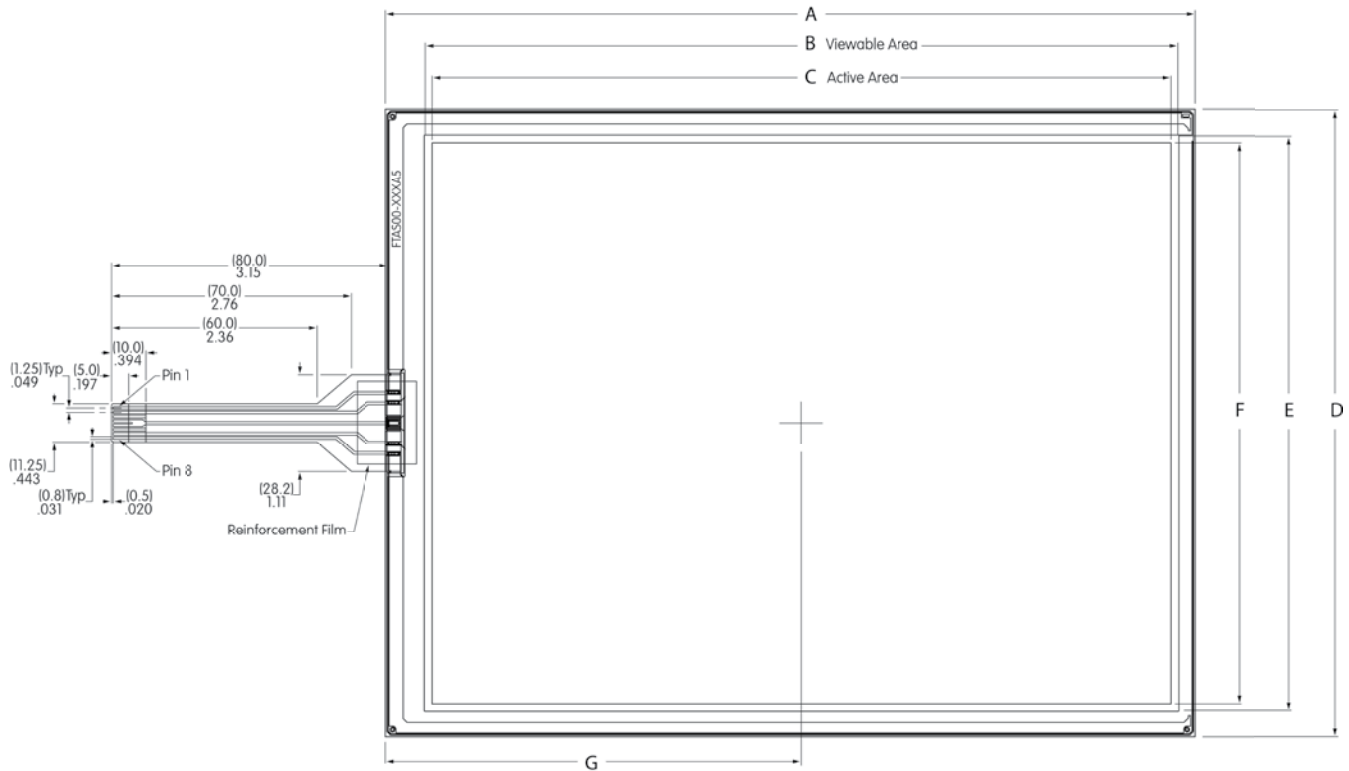

UL, LL, UR, LR: Bottom Electrode Terminal
SENSE: Top Electrode Terminal

Pins	Signal
1	UR
2	UL
3	NC
4,5	SENSE
6	NC
7	LL
8	LR

5-Wire Analog Touch Screen Dimensions

Part Number	Screen Size in Inches	Dim A	Dim B Viewable Area	Dim C Active Area	Dim D	Dim E Viewable Area	Dim F Active Area	Dim G Center of Active Area
FTAS00-10.4A-5	10.4	9.31 (236.5) +/-0.3	8.66 (219.9)	8.50 (215.9)	7.22 (183.3) +/-0.3	6.61 (167.9)	6.45 (163.9)	4.79 (121.55)
FTAS00-12.1A-5	12.1	10.52 (267.1) +/-0.3	9.94 (252.4)	9.80 (249.0)	8.10 (205.8) +/-0.3	7.50 (190.6)	7.37 (187.2)	5.37 (136.4)
FTAS00-15A-5	15.0	12.79 (324.8) +/-0.3	12.19 (309.5)	12.05 (306.1)	9.79 (248.7) +/-0.3	9.19 (233.5)	9.06 (230.1)	6.49 (164.95)

Toggles
 Rockers
 Pushbuttons
 Illuminated PB
 Programmable
 Keylocks
 Rotaries
 Slides
 Tactiles
 Tilt
 Touch
 Indicators
 Accessories
 Supplement

5-Wire Touch Screen Controller Boards & Drivers

DISTINCTIVE CHARACTERISTICS

- High Quality and Reliability
- Easy Integration Replacing Mouse Functionality
- Compatible with Control Board USB/RS232C
- Device Driver Compatible with Vista and Windows XP Operating Systems

Controller Boards Available for RS232C

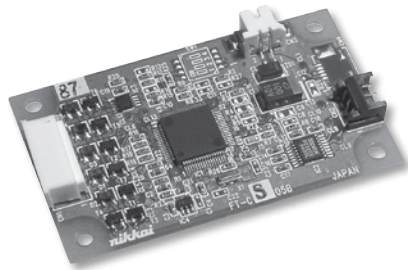

Controller Boards Available for USB

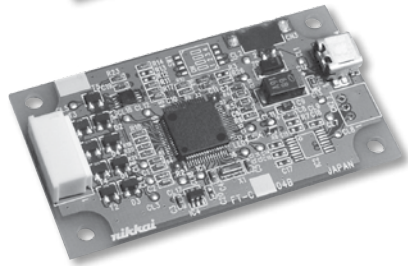

NKK offers controller boards compatible with USB or with RS232C. See web site or contact factory for specifications and technical data.

Controller Boards		
Type	Part No.	Communication Protocol
5-Wire	FTCS05B	RS232C
5-Wire	FTCU05B	USB

See web site for dimensioned drawings or technical data for any of the controller boards and drivers.

IC & Accessories

DISTINCTIVE CHARACTERISTICS

- Interface: USB and RS232C
- High Speed and Accuracy
- Built-in Calibration Function
- Data Function Removal Built In to Eliminate Noise

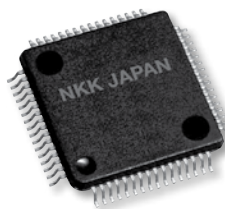

IC CSU 548

The IC is for use with the 5- and 4-wire transparent touch screens, and is available for those who prefer to design their own controller boards. When the screen is touched, it recognizes the position of the touch by the level of analog voltage detected by the A/D. The A/D converter receives the value and sends a set of coordinate values as serial data or USB.

See web site or contact factory for IC specifications.

OPTIONAL ACCESSORIES

AT713 Receptacle Connector

This Receptacle Connector with code connects to RS232C communication of the controller boards.

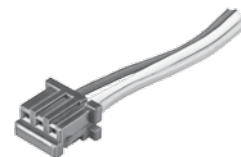

AT714 Receptacle Connector

AT714 is a Receptacle Connector with code to connect to power source of the control boards.



For more details and dimensioned drawings of the accessories, go to the web site or call our engineering support personnel.

General Specifications

Toggles
Rocker
Pushbuttons
Illuminated PB
Programmable
Keylocks
Rotaries
Slides
Tactiles
Tilt
Touch
Indicators
Accessories
Supplement

4-Wire Analog Resistive Touch Screens	
Power Level	1mA @ 5V DC (resistive load)
XY Resistive Value	Narrow: 250 ~ 850Ω Wide: 120 ~ 1,500Ω
Linearity	±1.5% maximum
Insulation Impedance	10MΩ minimum @ 25V DC
Expected Operational Life	Writing: 50,000 operations minimum (approximately 30mm movement with stylus)
	Tapping: 1,000,000 operations minimum (pressing force 4.9N using silicone rubber, hardness 60°)
Touch Activation Force	1.47N maximum
Chattering Time	10 milliseconds maximum
Relative Humidity	+60°C (+140°F), humidity 90%, 240 hours
Operating Temperature Range	-20°C ~ +70°C (-4°F ~ +158°F)
Storage Temperature Range	-40°C ~ +80°C (-40°F ~ +176°F)
Light Transmission	80% standard (Touch Panel portion)
Surface Hardness	2H minimum (JIS K5600)

APPLICATIONS

- Office Automation
- Industrial Automation
- Information Technology
- Banking Systems
- Medical Equipment
- Broadcast
- Hospitality
- Gaming/Entertainment

Cross Section View of Touch Screen

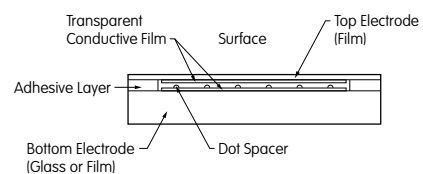

Specializing in Custom Products

- Custom sizes for Resistive Touch Screens
- Capability to attach touch screens to LCDs or other components
- Specializing in custom construction such as film plus film combinations
- Fingerprint resistant, high transmittance films
- Availability of metallic tails (i.e., copper pattern plus gold plate)

Control Board for Analog Touch Panels

- Combining an analog touch panel with a controller board device driver on a computer enables performing the same operations as with a mouse by touching the touch panel screen
- NKK offers controller boards compatible with USB or with RS232C

Distinctive Characteristics

Expansion of FT Series with more universal options include wider, larger and narrow frame types

Construction of film and glass with superior durability and flexibility

Choice of input methods: finger or stylus

Wide range of panel sizes in analog includes 5.7", 6.5", 8.4", 10.4", 10.6", 12.1", 15", 15.6" and 19"

Anti-Newton Ring (ANR) Technology eliminates many of the typical visual artifacts for analog types

Operator can easily direct the device without specialized technical training or computer knowledge by combining touch screen to LCD panel, plasma EL or other display

Touch screens support flexible design, including digital and analog, in a variety of sizes and relatively low cost

Anti-glare surface reduces reflection from fluorescent lighting, sunlight, etc.

Adhesive layer between glass and film has improved durability to withstand diverse environmental conditions

Hard resin coating on film's surface ensures excellent protection against scratches or damage



TYPICAL TOUCH SCREEN ORDERING EXAMPLE

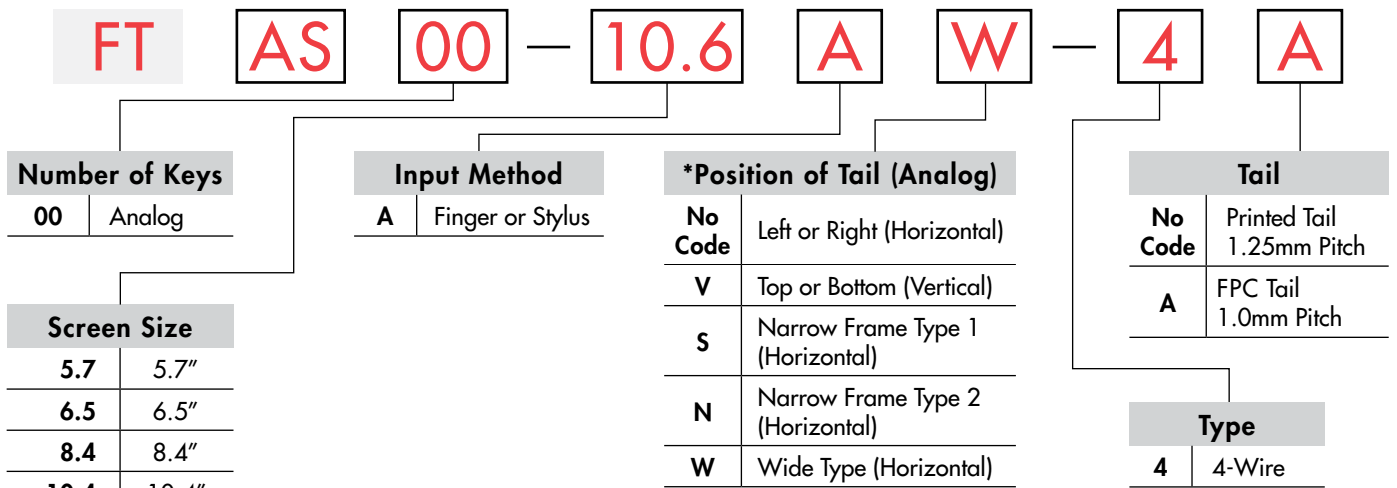

Screen Size	
5.7	5.7"
6.5	6.5"
8.4	8.4"
10.4	10.4"
10.6	10.6"
12.1	12.1"
15	15.0"
15.6	15.6"
19	19.0"

DESCRIPTION FOR TYPICAL ORDERING EXAMPLE

FTAS00-10.6AW-4











Touch Screen with
10.6" Screen
Finger or Stylus Input



Wide Type
(Horizontal Tail Position)
4-Wire Analog

* Aspect Ratio:
Narrow Frame: 4:3
Wide Frame: 16:9

PART NUMBERS & DESCRIPTIONS

			
FTAS00-5.7AS-4	FTAS00-6.5AS-4	FTAS00-8.4AS-4	FTAS00-10.4AS-4
			
FTAS00-10.4AV-4	FTAS00-12.1AN-4	FTAS00-15AN-4	FTAS00-19AN-4
			
FTAS00-10.6AW-4	FTAS00-12.1AW-4	FTAS00-15.6AW-4	

4-Wire Analog Touch Screens

Part Number	Screen Size in Inches	Key Area Dimensions	Viewing Area Dimensions	External Dimensions	Panel Thickness	Terminal Detail 8 Pin .049" (1.25mm) Pitch
FTAS00-5.7AS-4	5.7	4.54" x 3.40" (115.2mm x 86.4mm)	4.76" x 3.61" (121.0mm x 91.6mm)	5.16" x 3.98" (131.0mm x 101.0mm)	.055" (1.4mm)	Length 2.56" (65.0mm)
FTAS00-6.5AS-4	6.5	5.20" x 3.90" (132.0mm x 99.0mm)	5.43" x 4.13" (138.0mm x 105.0mm)	5.91" x 4.57" (150.0mm x 116.0mm)	.055" (1.4mm)	Length 2.56" (65.0mm)
FTAS00-8.4AS-4	8.4	6.73" x 5.10" (170.9mm x 129.6mm)	6.95" x 5.33" (176.5mm x 135.4mm)	7.34" x 5.69" (186.5mm x 144.4mm)	.083" (2.1mm)	Length 3.15" (80.0mm)
FTAS00-10.4AS-4	10.4	8.32" x 6.24" (211.2mm x 158.4mm)	8.47" x 6.39" (215.0mm x 162.4mm)	8.88" x 6.75" (225.6mm x 171.4mm)	.083" (2.1mm)	Length 3.15" (80.0mm)
FTAS00-10.4AV-4	10.4	8.35" x 6.28" (212.2mm x 159.4mm)	8.52" x 6.43" (216.4mm x 163.4mm)	8.92" x 7.21" (226.5mm x 183.0mm)	.083" (2.1mm)	Length 3.15" (80.0mm)
FTAS00-12.1AN-4	12.1	9.677" x 7.256" (245.8mm x 184.3mm)	9.827" x 7.406" (249.6mm x 188.1mm)	10.236" x 7.795" (260.0mm x 198.0mm)	.083" (2.1mm)	Length 3.15" (80.0mm)
FTAS00-15AN-4	15.0	11.972" x 8.980" (304.1mm x 228.1mm)	12.130" x 9.138" (308.1mm x 232.1mm)	12.669" x 9.665" (321.8mm x 245.5mm)	.083" (2.1mm)	Length 3.15" (80.0mm)
FTAS00-19AN-4	19.0	14.815" x 11.850" (376.3mm x 301.0mm)	15.039" x 12.102" (382.0mm x 307.4mm)	15.571" x 12.638" (395.5mm x 321.0mm)	.083" (2.1mm)	Length 3.15" (80.0mm)
FTAS00-10.6AW-4	10.6	9.071" x 5.441" (230.4mm x 138.2mm)	9.189" x 5.563" (233.4mm x 141.3mm)	9.756" x 6.094" (247.8mm x 154.8mm)	.083" (2.1mm)	Length 3.15" (80.0mm)
FTAS00-12.1AW-4	12.1	10.280" x 6.425" (261.12mm x 163.2mm)	10.404" x 6.551" (264.26mm x 166.4mm)	10.827" x 6.929" (275.0mm x 176.0mm)	.083" (2.1mm)	Length 3.15" (80.0mm)
FTAS00-15.6AW-4	15.6	13.551" x 7.618" (344.2mm x 193.5mm)	13.681" x 7.748" (347.5mm x 196.8mm)	14.276" x 8.433" (362.6mm x 214.2mm)	.083" (2.1mm)	Length 3.15" (80.0mm)

GENERAL SPECIFICATIONS FOR 4-WIRE

4-Wire with Horizontal Tail

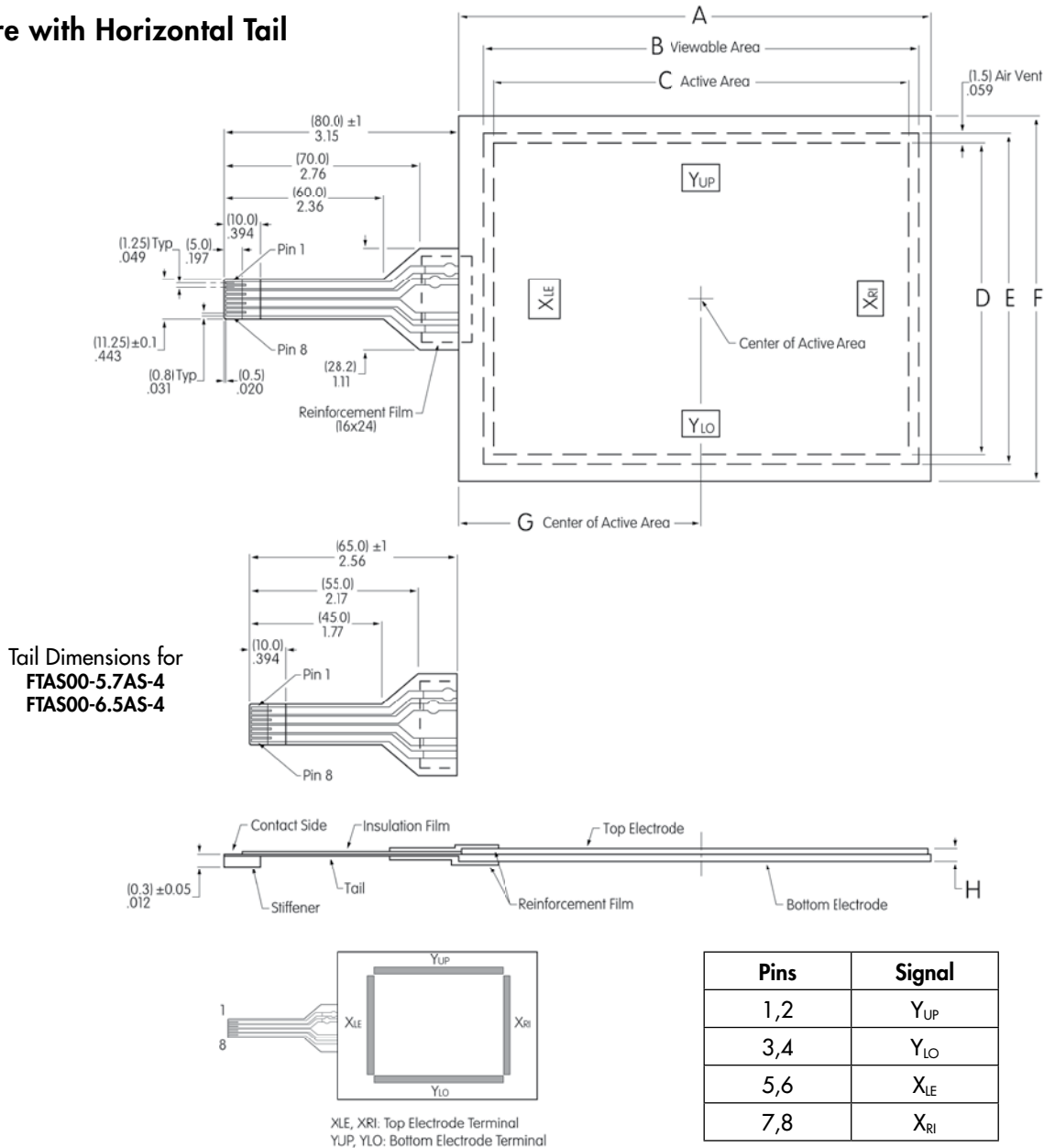

4-Wire Analog Touch Screen Dimensions									
Part Number	Screen Size in Inches	Dim A	Dim B Viewable Area	Dim C Active Area	Dim D	Dim E Viewable Area	Dim F Active Area	Dim G Center of Active Area	Dim H
FTAS00-5.7AS-4	5.7	5.16" (131±0.3mm)	4.76" (121mm)	4.54" (115.2mm)	3.40" (86.4mm)	3.61" (91.6mm)	3.98" (101±0.3mm)	2.65" (67.25mm)	.055" (1.4mm)
FTAS00-6.5AS-4	6.5	5.91" (150±0.3mm)	5.43" (138mm)	5.20" (132mm)	3.90" (99mm)	4.13" (105mm)	4.57" (116±0.3mm)	3.03" (77mm)	.055" (1.4mm)
FTAS00-8.4AS-4	8.4	7.34" (186.5±0.3mm)	6.95" (176.5mm)	6.73" (170.9mm)	5.10" (129.6mm)	5.33" (135.4mm)	5.69" (144.4±0.3mm)	3.73" (94.85mm)	.083" (2.1mm)
FTAS00-10.4AS-4	10.4	8.88" (225.6±0.3mm)	8.46" (215mm)	8.31" (211.2mm)	6.24" (158.4mm)	6.39" (162.4mm)	6.75" (171.4±0.3mm)	4.49" (114.1mm)	.083" (2.1mm)

Toggle
Rockers
Pushbuttons
Illuminated PB
Programmable
Keylocks
Rotaries
Slides
Tactiles
Tilt
Touch
Indicators
Accessories
Supplement

Toggles
 Rockers
 Pushbuttons
 Illuminated PB
 Programmable
 Keylocks
 Rotaries
 Slides
 Tactiles
 Tilt
Touch
 Indicators
 Accessories
 Supplement

GENERAL SPECIFICATIONS FOR 4-WIRE

4-Wire with Vertical Tail

FTAS00-10.4AV-4

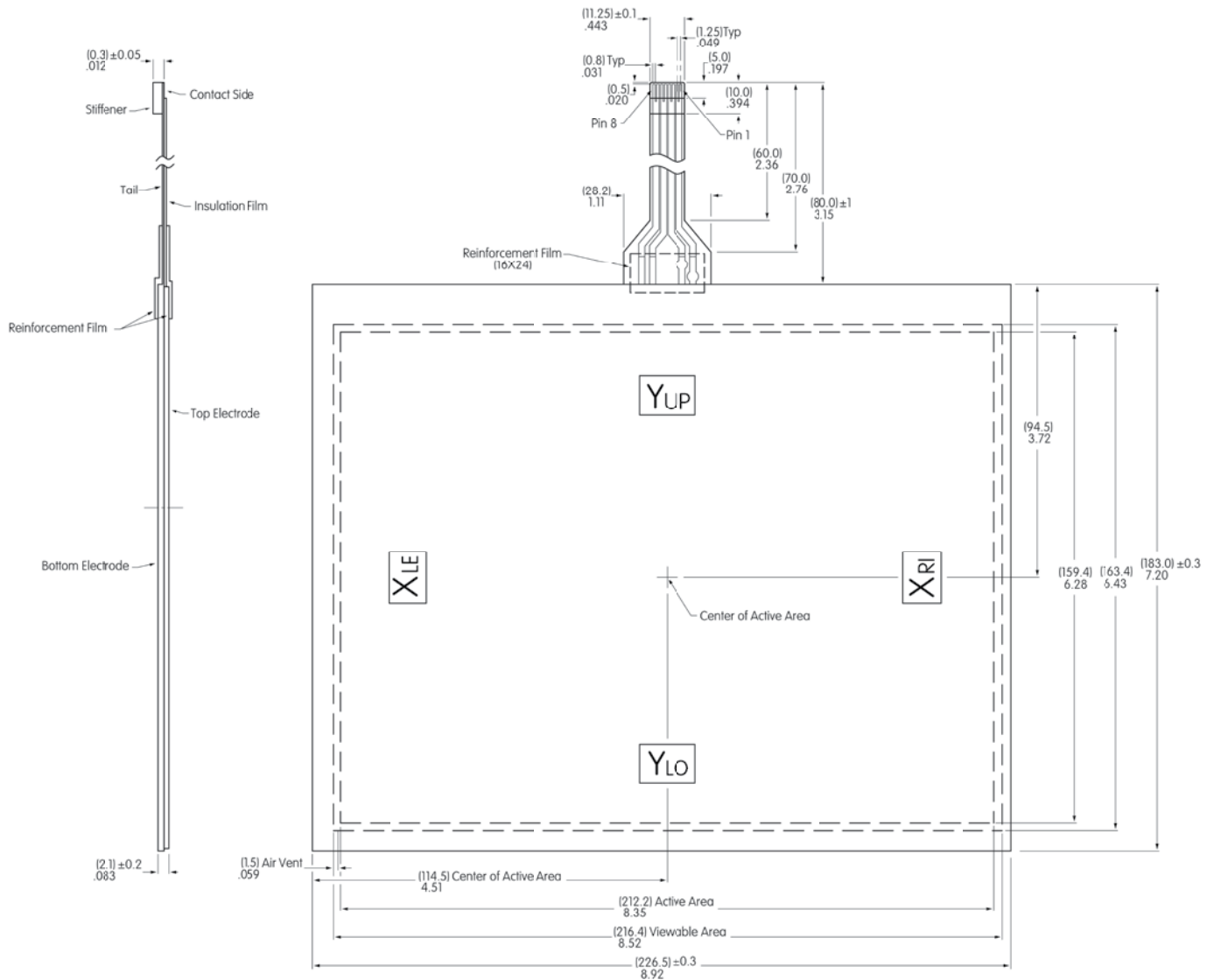

Pins	Signal
1, 2	Y _{UP}
3, 4	Y _{LO}
5, 6	X _{RI}
7, 8	X _{LE}

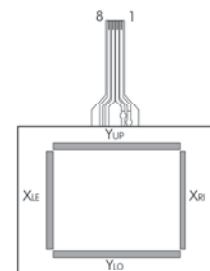

XLE, XRI: Top Electrode Terminal
 YUP, YLO: Bottom Electrode Terminal

GENERAL SPECIFICATIONS FOR 4-WIRE

4-Wire with Horizontal Tail & Narrow Frame

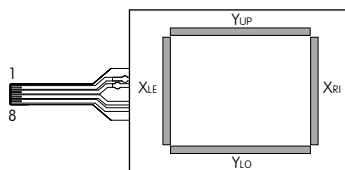
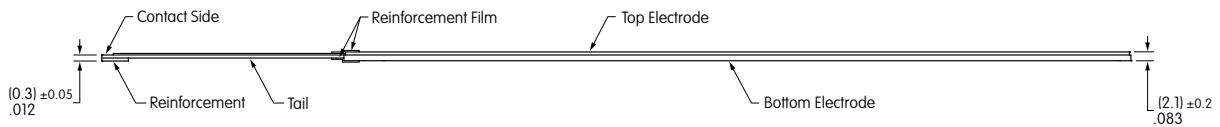
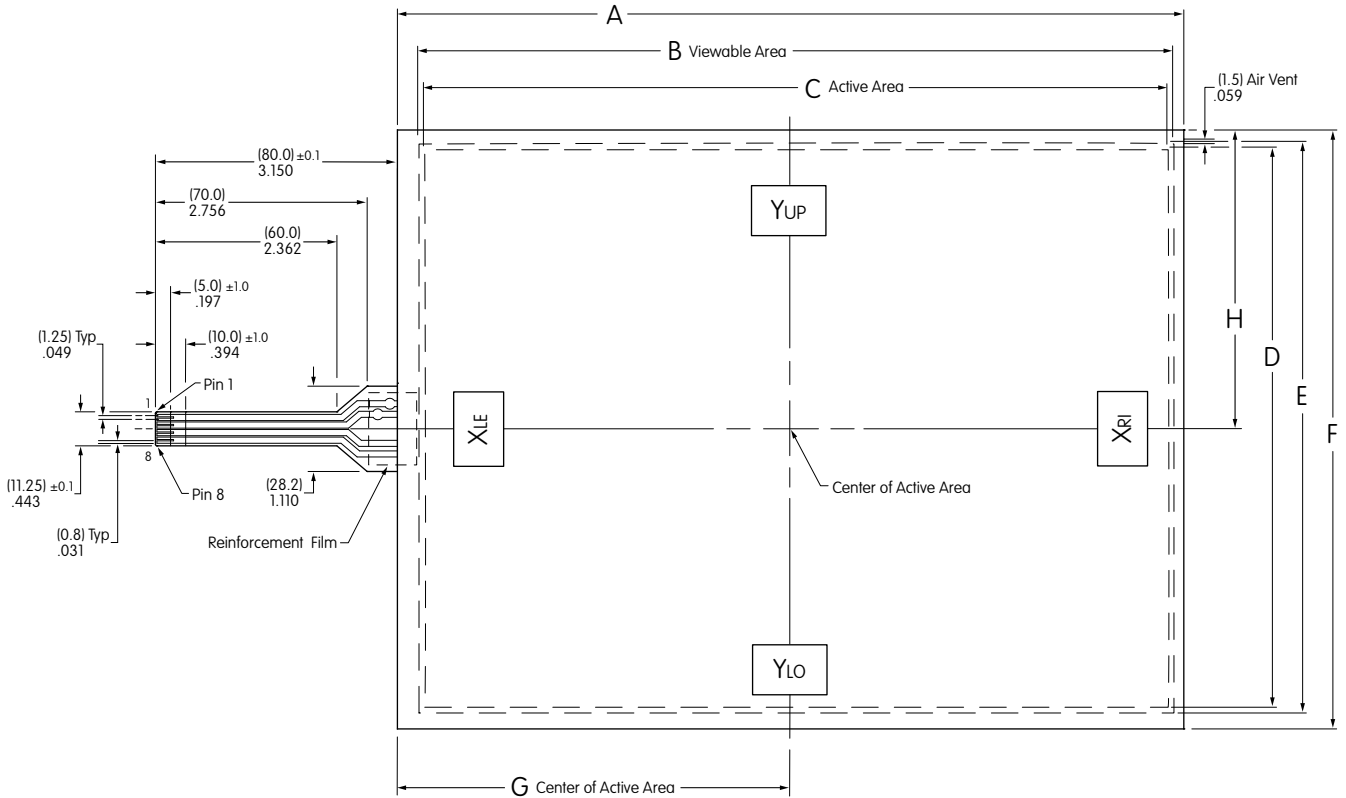

YUP, YLO: Top Electrode Terminal
XLE, XRI: Bottom Electrode Terminal

Pins	Signal
1, 2	Y _{UP}
3, 4	Y _{LO}
5, 6	X _{LE}
7, 8	X _{RI}

4-Wire Analog Touch Screen Dimensions

Part Number	Screen Size in Inches	Dim A	Dim B Viewable Area	Dim C Active Area	Dim D Active Area	Dim E Viewable Area	Dim F	Dim G Center of Active Area (Horizontal)	Dim H Center of Active Area (Vertical)
FTAS00-12.1AN-4	12.1	10.236" (260.0±0.3mm)	9.827" (249.6mm)	9.677" (245.8mm)	7.256" (184.3mm)	7.406" (188.1mm)	7.795" (198.0±0.3mm)	5.177" (131.5mm)	3.850" (97.8mm)
FTAS00-15AN-4	15.0	12.669" (321.8±0.3mm)	12.130" (308.1mm)	11.972" (304.1mm)	8.980" (228.1mm)	9.138" (232.1mm)	9.665" (245.5±0.3mm)	6.398" (162.5mm)	4.833" (122.75mm)
FTAS00-19AN-4	19.0	15.571" (395.5±0.3mm)	15.039" (382.0mm)	14.815" (376.3mm)	11.850" (301.0mm)	12.102" (307.4mm)	12.638" (321.0±0.3mm)	7.799" (198.1mm)	6.319" (160.5mm)

Toggles
Rockers
Pushbuttons
Illuminated PB
Programmable
Keylocks
Rotaries
Slides
Tactiles
Tilt
Touch
Indicators
Accessories
Supplement

GENERAL SPECIFICATIONS FOR 4-WIRE

4-Wire with Horizontal Tail & Wide Frame

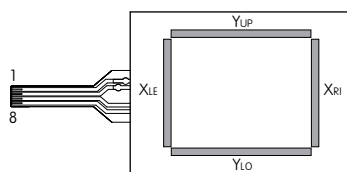
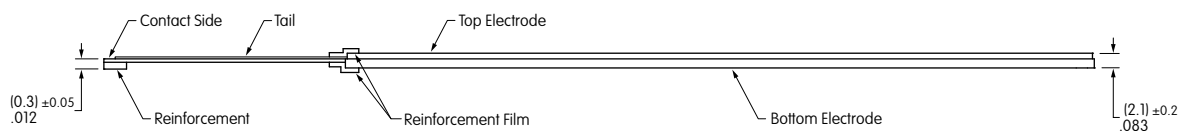
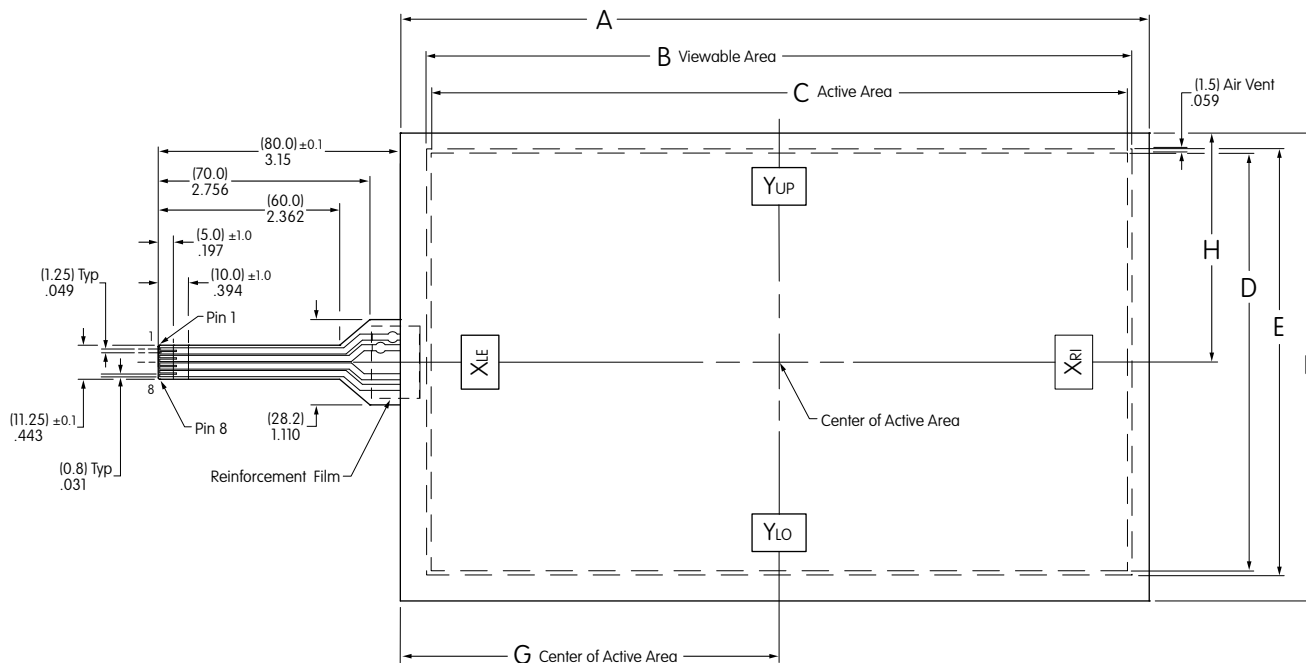

YUP, YLO: Top Electrode Terminal
XLE, XRI: Bottom Electrode Terminal

Pins	Signal
1, 2	Y _{UP}
3, 4	Y _{LO}
5, 6	X _{LE}
7, 8	X _{RI}

4-Wire Analog Touch Screen Dimensions

Part Number	Screen Size in Inches	Dim A	Dim B Viewable Area	Dim C Active Area	Dim D Active Area	Dim E Viewable Area	Dim F	Dim G Center of Active Area (Horizontal)	Dim H Center of Active Area (Vertical)
FTAS00-10.6AW-4	10.6	9.756" (247.8±0.3mm)	9.189" (233.4mm)	9.071" (230.4mm)	5.441" (138.2mm)	5.563" (141.3mm)	6.094" (154.8±0.3mm)	4.933" (125.3mm)	2.984" (75.8mm)
FTAS00-12.1AW-4	12.1	10.827" (275.0±0.3mm)	10.404" (264.26mm)	10.280" (261.12mm)	6.425" (163.2mm)	6.551" (166.4mm)	6.929" (176.0±0.3mm)	5.468" (138.89mm)	3.465" (88.0mm)
FTAS00-15.6AW-4	15.6	14.276" (362.6±0.3mm)	13.681" (347.5mm)	13.551" (344.2mm)	7.618" (193.5mm)	7.748" (196.8mm)	8.433" (214.2±0.3mm)	7.138" (181.3mm)	4.217" (107.1mm)

4-Wire Touch Screen Controller Boards & Drivers

DISTINCTIVE CHARACTERISTICS

- Compatible with Control Board USB/RS232C
- Equipped with EPROM for Saving Setting Data
- Device Drivers are Windows 7 and 8 Compatible

Controller Boards		
Type	Part No.	Communication Protocol
4-Wire	FTCS04A/FTCS04A2	RS232C
4-Wire	FTCS04B	RS232C
4-Wire	FTCU04B	USB

System Configuration for USB

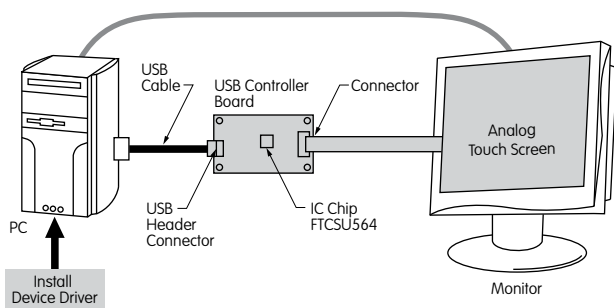

System Configuration for RS232C

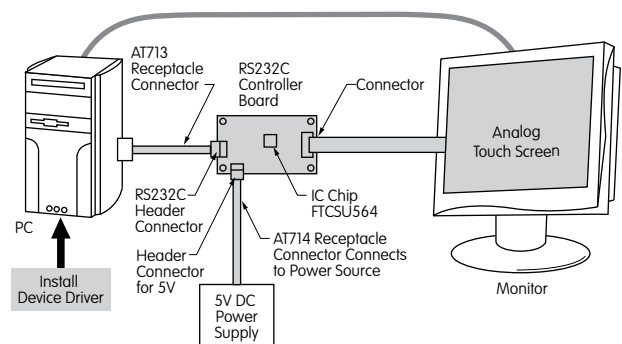

Available through NKK Switches

Touch panels can be operated the same as PC mouse functions by combining a control board or device driver and analog touch screen. For specifications or technical data for the controller boards and drivers, see NKK's web site or call our engineering support personnel.

General Specifications

Items	FTCS04A & FTCS04A2	FTCS04B	FTCU04B
Interface	RS232C	RS232C	USB 2.0 Full Speed
Clock	10MHz	6MHz	6MHz
Supply Voltage	5.0V	5.0V	5.0V
Resolution	10bit	10bit	10bit
Current Consumption	40mA maximum	40mA maximum	100mA maximum
Communication Speed	*1200, 2400, 4800, 9600, 19,200 bps (Standard is 9600 bps)	9600 bps	—
Communication Format	Data Length: 8bit Parity: None, Odd Number, Even Number Stop Bit: 1, 2	Data Length: 8bit Parity: None Stop Bit: 1	—

*Applies to FTCS04A only; may be changed by commanding from host on FTCS04A2

Absolute Maximum Ratings

Items	Symbols	Minimum	Maximum	Notes
Supply Voltage	V _{CC}	-0.3V	+5.5V (+6V)**	—
Input Voltage	V _{TP}	—	V _{CC} (V _{CC} +0.3)**	Touch Screen Input
	*V _{RS}	-15V(-25V)**	+15V (+25V)**	RS232C
Operating Temperature	T _{OPR}	0°C (+32°F)	+70°C (+158°F)	—
Storage Temperature	T _{STG}	-25°C (-13°F)	+85°C (+185°F)	—

*V_{RS}: Applies Only to RS232C ()**Applies to FTCS04A & FTCS04A2

Recommended Values

Items	Symbols	Minimum	Typical	Maximum	Notes
Supply Voltage	V _{CC}	+4.75V (+4.5V)**	+5	+5.25V (+5.5V)**	—
Operating Temperature	T _{OPR}	0	—	+70°C (+158°F)	No Condensation

()**Applies to FTCS04A & FTCS04A2

4-Wire Touch Screen Controller Boards & Drivers

DISTINCTIVE CHARACTERISTICS

- Device Driver function: Emulation software that enables operation of the touch screen same as a PC mouse
- Device Driver features two types of button modes; can be operated simultaneously with PS/2 mouse
- Device Driver Compatible with Windows 7 and 8 Operating Systems
- RS232C Controller Board consists of connector for 4-wire analog touch screen, RS232C header connector, 5V power supply header connector and helps simplify wiring. RS232C receptacle connector with wire assembly (AT713) and 5V power receptacle connector with wire assembly (AT714), are available as accessories.

AT713 Receptacle Connector

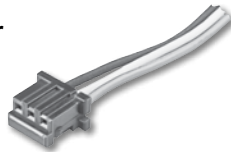

AT714 Receptacle Connector



Controller Board	Operating System
FTCS04B FTCU04B	Windows 7 and 8
FTCS04A	Windows 7 and 8
FTCS04A2	Device Driver Not Available

NKK offers controller boards compatible with USB or RS232C. Refer to data sheets for FTCS04A, FTCS04B or FTCU04B. See website or contact NKK Switches for specifications and technical data.

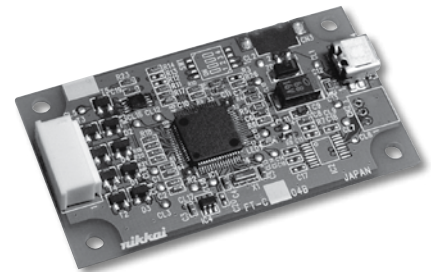

Controller Boards Available for USB and RS232C

IC Chip for Analog Touch Screens

DISTINCTIVE CHARACTERISTICS

- Interface: USB and RS232C
- High Speed and Accuracy
- Built-in Calibration Function
- Data Function Removal Built In to Eliminate Noise

The IC is for use with the 4- and 5-wire transparent touch screens. When the screen is touched, it recognizes the position of the touch by the level of analog voltage detected by the A/D. The A/D converter receives the value and sends a set of coordinate values as serial data or USB.

Contact NKK Switches for the IC data sheet.

General Specifications for IC FTCSU548	
Package	LFQFP 48 Pins
Interface	Serial Interface (Asynchronous) or USB (Full Speed 2.0)
Supply Voltage	3.3/5.0V Typ; USB Available for 5V Only
* Rated Output Current	High Level: -170mA Low Level: +170mA
Operation Frequency	16MHz
A/D Converter Resolution	10bit
Operating Temperature	-20°C ~ +85°C (-4°F ~ +185°F)
Storage Temperature	-40°C ~ +125°C (-40°F ~ +257°F)
* Total Output Electric Current Amount of all the I/O Port	

Toggles
Rockers
Pushbuttons
Illuminated PB
Programmable
Keylocks
Rotaries
Slides
Tactiles
Tilt
Touch
Indicators
Accessories
Supplement

Controller Boards for RS232C

FTCS04A & FTCS04A2

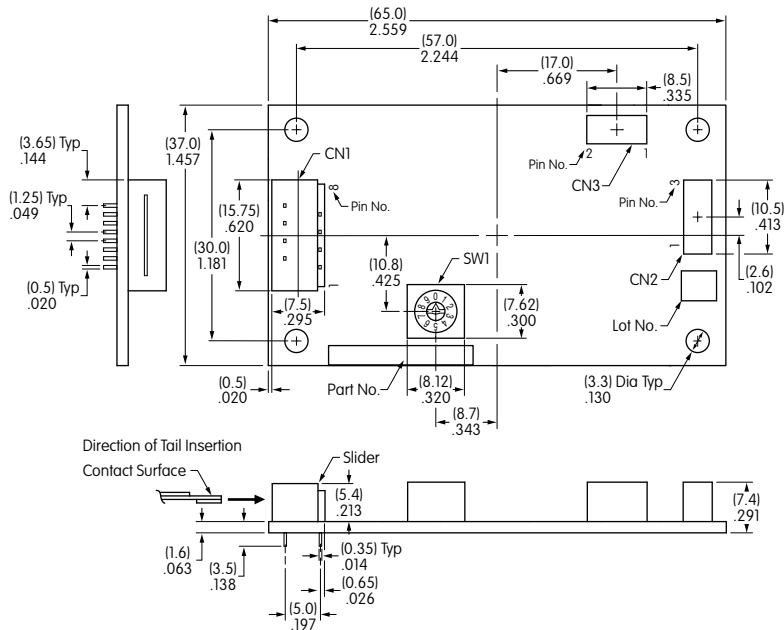

CN1 4-Wire Analog Touch Screen Connector - 8 Pins

Pin No.	Symbol	Description
1, 2	Y0	For Y _{UP} or Y _{LO}
3, 4	Y1	
5, 6	X0	For X _{RI} or X _{LE}
7, 8	X1	

CN2 RS232C Header Connector - 3 Pins

Pin No.	Symbol	Description
1	RD	Receiving Data
2	SD	Sending Data
3	GND	GND

CN3 Header Connector for Power Supply - 2 Pins

Pin No.	Symbol	Description
1	V _{CC}	Supply Voltage
2	GND	GND

FTCS04B for RS232C

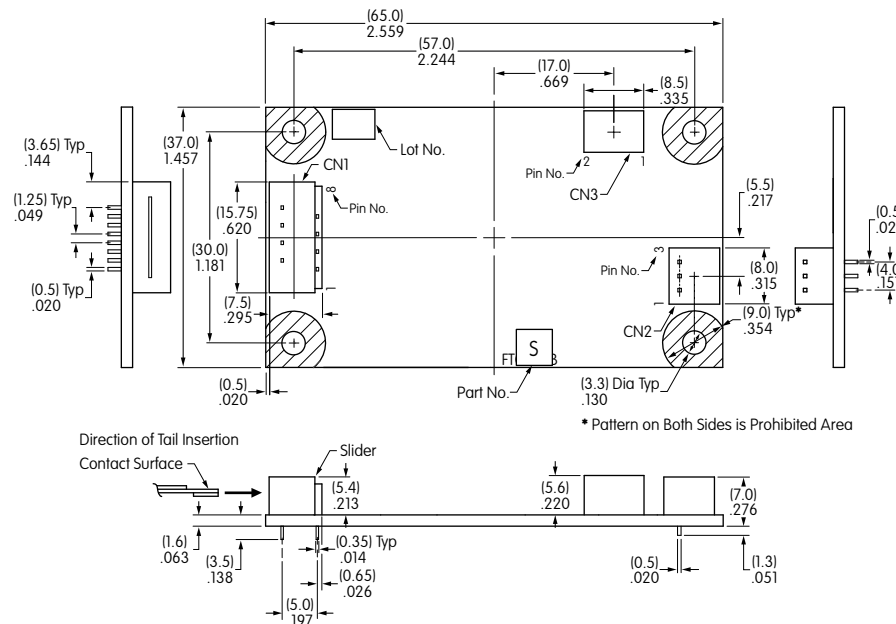

CN1 4-Wire Analog Touch Screen Connector - 8 Pins

Pin No.	Symbol	Description
1, 2	Y0	For Y _{UP} or Y _{LO}
3, 4	Y1	
5, 6	X0	For X _{RI} or X _{LE}
7, 8	X1	

CN2 RS232C Header Connector - 3 Pins

Controller Board Side			
Pin No.	Symbol	Description	Computer Side
1	RD	Receiving Data (IN)	Sending Data
2	SD	Sending Data (OUT)	Receiving Data
3	GND	GND	GND

CN3 Header Connector for Power Supply - 2 Pins

Pin No.	Symbol	Description
1	V _{CC}	Supply Voltage
2	GND	GND

OPTIONAL ACCESSORIES

Receptacle Connector & Wire Assembly for RS232C

AT713 is the Receptacle Connector with code to connect to RS232C communication of the controller boards. It is compatible with FTCS04A and FTCS04A2. The cable length is adjustable.

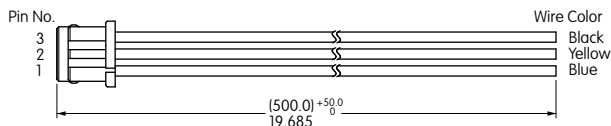

Receptacle Connector & Wire Assembly for Power Supply

AT714 is a Receptacle Connector with code to connect to FTCS04A or FTCS04A2 power source of the control boards. The cable length is adjustable.

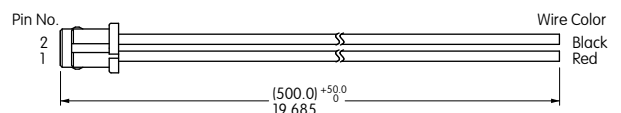

Controller Board for USB

FTCU04B for USB

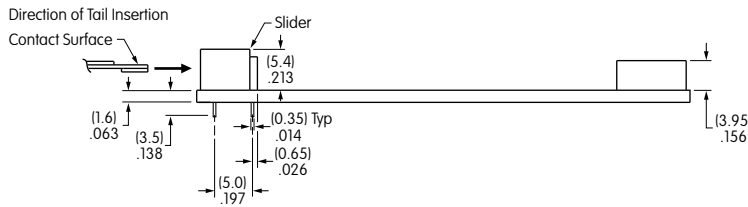
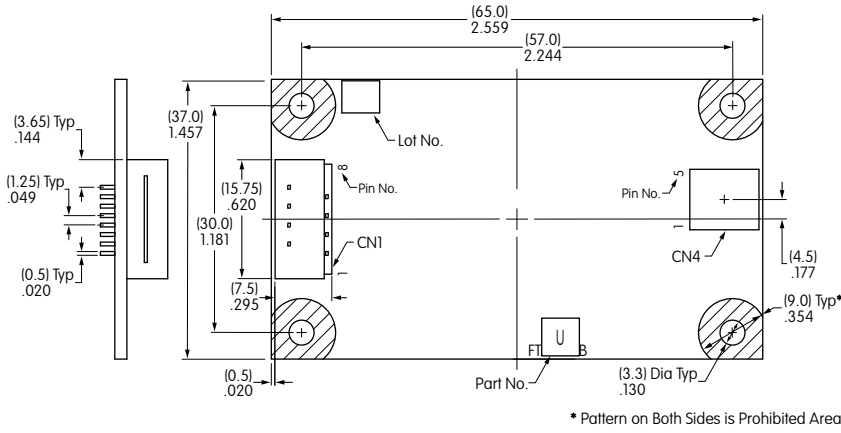









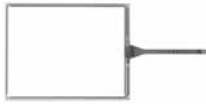

CN1 4-Wire Analog Touch Screen Connector - 8 Pins

Pin No.	Symbol	Description
1, 2	Y0	For Y _{UP} or Y _{LO}
3, 4	Y1	
5, 6	X0	For X _{RI} or X _{LE}
7, 8	X1	

CN4 Header Connector for USB - 5 Pins

Pin No.	Symbol	Description
1	V _{CC}	USB V _{CC}
2	D ₋	USB D ₋
3	D ₊	USB D ₊
4	GND	USB GND
5	GND	Shield GND

PART NUMBERS & DESCRIPTIONS

 FTAS00-5.7AS-4A	 FTAS00-6.5AS-4A	 FTAS00-8.4AS-4A	 FTAS00-10.4AS-4A
 FTAS00-10.4AV-4A	 FTAS00-10.6AW-4A	 FTAS00-12.1AN-4A	 FTAS00-12.1AW-4A
 FTAS00-15AN-4A		 FTAS00-15.6AW-4A	 FTAS00-19AN-4A

4-Wire Analog Touch Screens

Tail	Part Number	Screen Size in Inches	Key Area Dimensions	Viewing Area Dimensions	External Dimensions	Panel Thickness	Terminal Detail 4 Pin .039" (1.0mm) Pitch
Narrow Frame Type 1 Horizontal Tail	FTAS00-5.7AS-4A	5.7	4.535" x 3.402" (115.2mm x 86.4mm)	4.764" x 3.606" (121.0mm x 91.6mm)	5.157" x 3.976" (131.0mm x 101.0mm)	.055" (1.4mm)	Length 3.150" (80.0mm)
	FTAS00-6.5AS-4A	6.5	5.197" x 3.898" (132.0mm x 99.0mm)	5.433" x 4.134" (138.0mm x 105.0mm)	5.906" x 4.567" (150.0mm x 116.0mm)	.055" (1.4mm)	Length 3.150" (80.0mm)
	FTAS00-8.4AS-4A	8.4	6.728" x 5.102" (170.9mm x 129.6mm)	6.949" x 5.331" (176.5mm x 135.4mm)	7.343" x 5.685" (186.5mm x 144.4mm)	.083" (2.1mm)	Length 3.150" (80.0mm)
	FTAS00-10.4AS-4A	10.4	8.315" x 6.236" (211.2mm x 158.4mm)	8.465" x 6.394" (215.0mm x 162.4mm)	8.882" x 6.748" (225.6mm x 171.4mm)	.083" (2.1mm)	Length 3.150" (80.0mm)
Vertical Tail	FTAS00-10.4AV-4A	10.4	8.354" x 6.276" (212.2mm x 159.4mm)	8.520" x 6.433" (216.4mm x 163.4mm)	8.917" x 7.205" (226.5mm x 183.0mm)	.083" (2.1mm)	Length 3.150" (80.0mm)
Narrow Frame Type 2 Horizontal Tail	FTAS00-12.1AN-4A	12.1	9.677" x 7.256" (245.8mm x 184.3mm)	9.827" x 7.406" (249.6mm x 188.1mm)	10.236" x 7.795" (260.0mm x 198.0mm)	.083" (2.1mm)	Length 3.150" (80.0mm)
	FTAS00-15AN-4A	15.0	11.972" x 8.980" (304.1mm x 228.1mm)	12.130" x 9.138" (308.1mm x 232.1mm)	12.669" x 9.665" (321.8mm x 245.5mm)	.083" (2.1mm)	Length 3.150" (80.0mm)
	FTAS00-19AN-4A	19.0	14.815" x 11.850" (376.3mm x 301.0mm)	15.039" x 12.102" (382.0mm x 307.4mm)	15.571" x 12.638" (395.5mm x 321.0mm)	.083" (2.1mm)	Length 3.150" (80.0mm)
Wide Type Horizontal Tail	FTAS00-10.6AW-4A	10.6	9.071" x 5.441" (230.4mm x 138.2mm)	9.189" x 5.563" (233.4mm x 141.3mm)	9.756" x 6.094" (247.8mm x 154.8mm)	.083" (2.1mm)	Length 3.150" (80.0mm)
	FTAS00-12.1AW-4A	12.1	10.280" x 6.425" (261.12mm x 163.2mm)	10.404" x 6.551" (264.26mm x 166.4mm)	10.827" x 6.929" (275.0mm x 176.0mm)	.083" (2.1mm)	Length 3.150" (80.0mm)
	FTAS00-15.6AW-4A	15.6	13.551" x 7.618" (344.2mm x 193.5mm)	13.681" x 7.748" (347.5mm x 196.8mm)	14.276" x 8.433" (362.6mm x 214.2mm)	.083" (2.1mm)	Length 3.150" (80.0mm)

Toggles
 Rockers
 Pushbuttons
 Illuminated PB
 Programmable
 Keylocks
 Rotaries
 Slides
 Tactiles
 Tilt
 Touch
 Indicators
 Accessories
 Supplement

TYPICAL DIMENSIONS

Vertical Frame

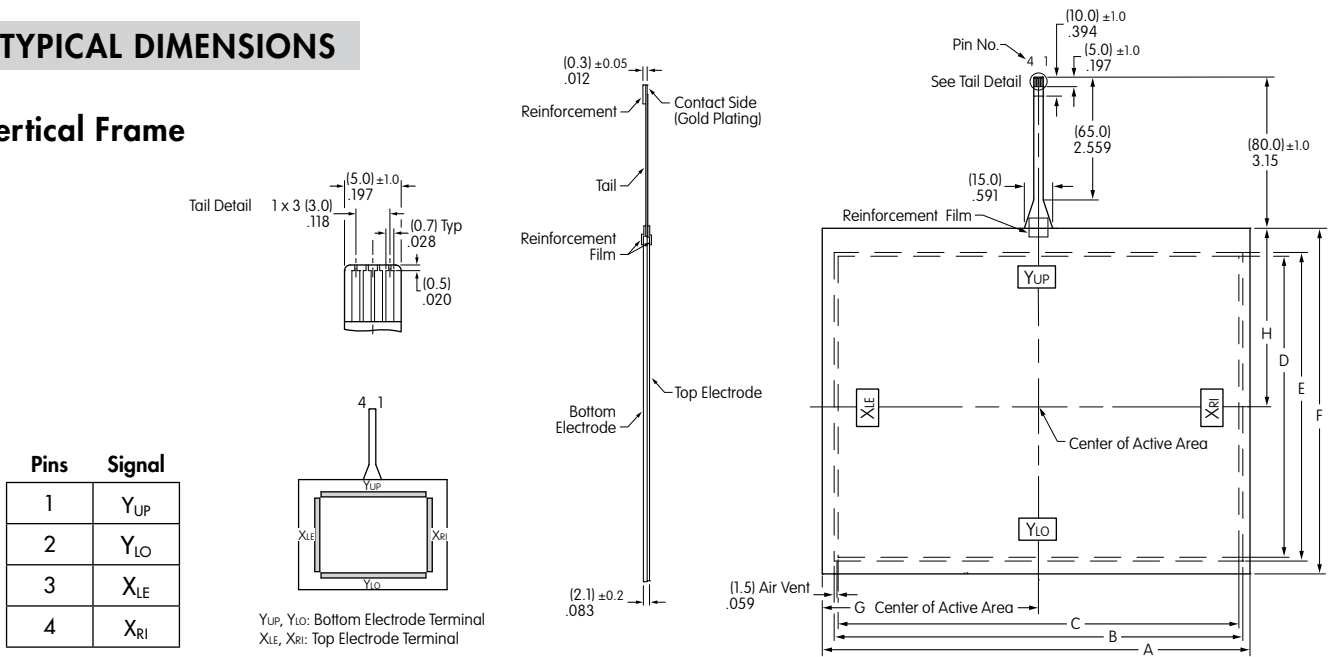

Typical Dimensions for Vertical Frame

Part Number	Screen Size in Inches	Dim A	Dim B Viewable Area	Dim C Active Area	Dim D Active Area	Dim E Viewable Area	Dim F	Dim G Center of Active Area (Horizontal)	Dim H Center of Active Area (Vertical)
FTAS00-10.4AV-4A	10.4	8.917" (226.5±0.3mm)	8.520" (216.4mm)	8.354" (212.2mm)	6.276" (159.4mm)	6.433" (163.4mm)	7.205" (183.0±0.3mm)	4.508" (114.5mm)	3.720" (94.5mm)

TYPICAL DIMENSIONS

Wide Horizontal Frame

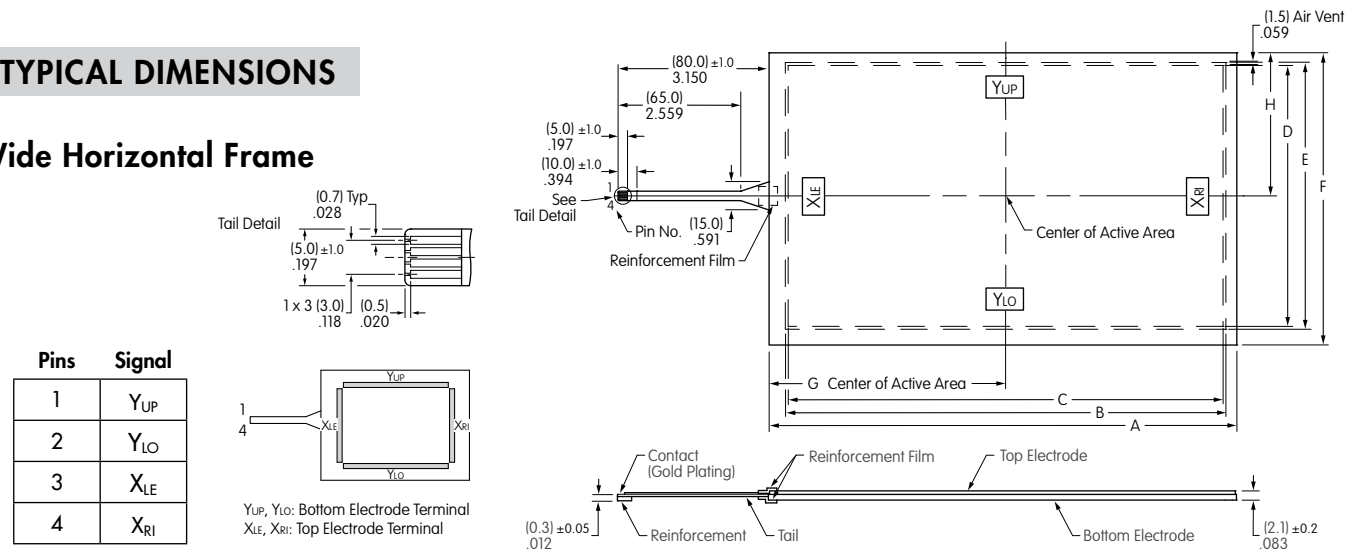

Typical Dimensions for Wide Horizontal Frame

Part Number	Screen Size in Inches	Dim A	Dim B Viewable Area	Dim C Active Area	Dim D Active Area	Dim E Viewable Area	Dim F	Dim G Center of Active Area (Horizontal)	Dim H Center of Active Area (Vertical)
FTAS00-10.6AW-4A	10.4	8.917" (247.8±0.3mm)	8.520" (233.4mm)	8.354" (230.4mm)	6.276" (138.2mm)	6.433" (141.3mm)	7.205" (154.8±0.3mm)	4.508" (125.3mm)	3.720" (75.8mm)
FTAS0012.1AW-4A	12.1	10.827" (275.0±0.3mm)	10.404" (264.26mm)	10.280" (261.12mm)	6.425" (163.2mm)	6.551" (166.4mm)	6.929" (176±0.3mm)	5.468" (138.89mm)	—
FTAS0015.6AW-4A	15.6	14.276" (362.6±0.3mm)	13.681" (347.5mm)	13.551" (344.2mm)	7.618" (193.5mm)	7.748" (196.8mm)	8.433" (214.2±0.3mm)	7.138" (181.3mm)	—

TYPICAL DIMENSIONS

Narrow Frame & Horizontal Tail

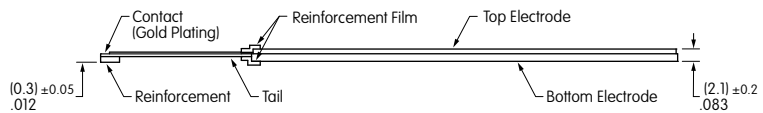
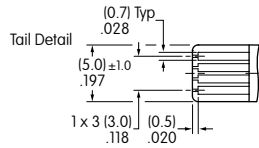
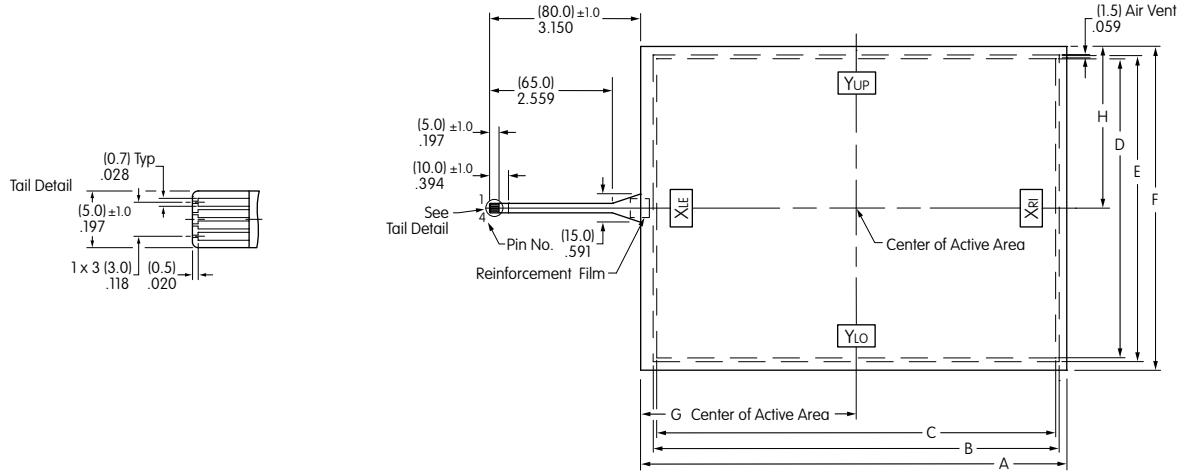

Pins	Signal
1	Y _{UP}
2	Y _{LO}
3	X _{LE}
4	X _{RI}

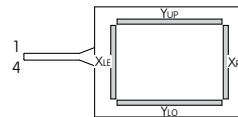

Y_{UP}, Y_{LO}: Bottom Electrode Terminal
X_{LE}, X_{RI}: Top Electrode Terminal

Typical Dimensions for Narrow Frame

Part Number	Screen Size in Inches	Dim A	Dim B Viewable Area	Dim C Active Area	Dim D Active Area	Dim E Viewable Area	Dim F	Dim G Center of Active Area (Horizontal)	Dim H Center of Active Area (Vertical)
FTAS00-5.7AS-4A	5.7	5.157" (131.0±0.3mm)	4.764" (121.0mm)	4.535" (115.2mm)	3.402" (86.4mm)	3.606" (91.6mm)	3.976" (101.0±0.3mm)	2.648" (67.25mm)	—
FTAS00-6.5AS-4A	6.5	5.906" (150.0±0.3mm)	5.433" (138.0mm)	5.197" (132.0mm)	3.898" (99.0mm)	4.134" (105.0mm)	4.567" (116.0±0.3mm)	3.031" (77.0mm)	—
FTAS00-8.4AS-4A	8.4	7.343" (186.5±0.3mm)	6.949" (176.5mm)	6.728" (170.9mm)	5.102" (129.6mm)	5.331" (135.4mm)	5.685" (144.4±0.3mm)	3.734" (94.85mm)	—
FTAS00-10.4AS-4A	10.4	8.882" (225.6±0.3mm)	8.465" (215.0mm)	8.315" (211.2mm)	6.236" (158.4mm)	6.394" (162.4mm)	6.748" (171.4±0.3mm)	4.492" (114.1mm)	—
FTAS00-12.1AN-4A	12.1	10.236" (260.0±0.3mm)	9.827" (249.6mm)	9.677" (245.8mm)	7.256" (184.3mm)	7.406" (188.1mm)	7.795" (198.0±0.3mm)	5.177" (131.5mm)	3.850" (97.8mm)
FTAS00-15AN-4A	15.0	12.669" (321.8±0.3mm)	12.130" (308.1mm)	11.972" (304.1mm)	8.980" (228.1mm)	9.138" (232.1mm)	9.665" (245.5±0.3mm)	6.398" (162.5mm)	—
FTAS00-19AN-4A	19.0	15.571" (395.5±0.3mm)	15.039" (382.0mm)	14.815" (376.3mm)	11.850" (301.0mm)	12.102" (307.4mm)	12.638" (321.0±0.3mm)	7.799" (198.1mm)	—

4-Wire Touch Screen Controller Boards & Drivers

DISTINCTIVE CHARACTERISTICS

- Compatible with Control Board USB/RS232C
- Equipped with EPROM for Saving Setting Data
- Device Drivers are Windows 7, 8 & 10 Compatible

Controller Boards		
Type	Part No.	Communication Protocol
4-Wire	FTCS04C	RS232C
4-Wire	FTCU04C	USB

System Configuration for USB

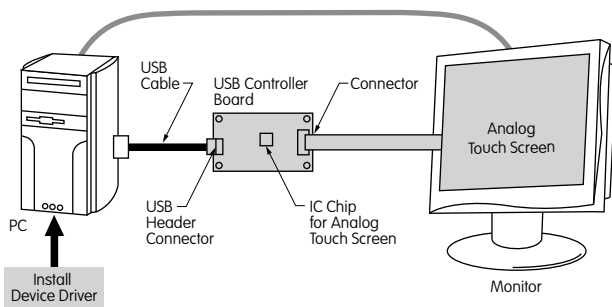

System Configuration for RS232C

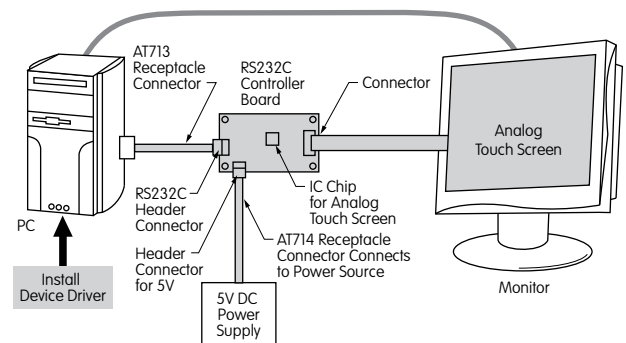

■ Available through NKK Switches

Touch panels can be operated the same as PC mouse functions by combining a control board or device driver and analog touch screen. For specifications or technical data for the controller boards and drivers, see NKK's web site or call our engineering support personnel.

General Specifications

Items	FTCS04C	FTCU04C
Interface	RS232C	USB 2.0 Full Speed
Clock	16MHz	16MHz
Supply Voltage	5.0V	5.0V (Bus Power)
Resolution	10bit	10bit
Current Consumption	40mA maximum	100mA maximum
Communication Speed	9600 bps	—
Communication Format	Data Length: 8bit Parity: None Stop Bit: 1	—

The controller board is designed specifically for touch screens with the FPC tails. Refer to the product data sheet for detailed specifications, available by contacting NKK Switches.

Absolute Maximum Ratings

Items	Symbols	Minimum	Maximum	Notes
Supply Voltage	V_{CC}	-0.3V	+5.5V	—
Input Voltage	V_{TP}	—	V_{CC}	Touch Panel Input
	$*V_{RS}$	-15V	+15V	RS232C
Operating Temperature	T_{OPR}	-20°C -4°F	+70°C +158°F	—
Storage Temperature	T_{STG}	-25°C -13°F	+85°C +185°F	—

* V_{RS} : Applies Only to RS232C

Recommended Values

Items	Symbols	Minimum	Typical	Maximum	Notes
Supply Voltage	V_{CC}	+4.75V	+5.0	+5.25V	—
Operating Temperature	T_{OPR}	-20°C -4°F	—	+70°C +158°F	No Condensation

4-Wire Touch Screen Controller Boards & Drivers

DISTINCTIVE CHARACTERISTICS

- Device Driver function: Emulation software that enables operation of the touch screen same as a PC mouse
- Device Driver features two types of button modes; can be operated simultaneously with PS/2 mouse
- Device Driver Compatible with Windows 7 and 8 Operating Systems
- RS232C Controller Board consists of connector for 4-wire analog touch screen, RS232C header connector, 5V power supply header connector and helps simplify wiring. RS232C receptacle connector with wire assembly (AT713) and 5V power receptacle connector with wire assembly (AT714), are available as accessories.

AT713 Receptacle Connector

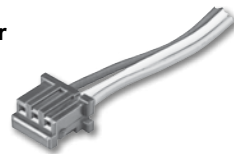

AT714 Receptacle Connector



Controller Board	Operating System
FTCS04C FTCU04C	Windows 7 and 8

NKK offers controller boards compatible with USB or RS232C. Refer to data sheets for FTCS04C or FTCU04C. See website or contact NKK Switches for specifications and technical data.

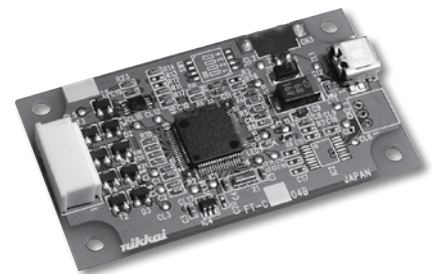

Controller Boards Available for USB and RS232C

IC Chip for Analog Touch Screens

DISTINCTIVE CHARACTERISTICS

- Interface: USB and RS232C
- High Speed and Accuracy
- Built-in Calibration Function
- Data Function Removal Built In to Eliminate Noise

The IC is for use with the 4- and 5-wire transparent touch screens. When the screen is touched, it recognizes the position of the touch by the level of analog voltage detected by the A/D. The A/D converter receives the value and sends a set of coordinate values as serial data or USB.

Contact NKK Switches for the IC data sheet.

General Specifications for IC FTCSU548	
Package	LQFP 48 Pins
Interface	Serial Interface (Asynchronous) or USB (Full Speed 2.0)
Supply Voltage	3.3/5.0V Typ; USB Available for 5V Only
* Rated Output Current	High Level: -170mA Low Level: +170mA
Operation Frequency	16MHz
A/D Converter Resolution	10bit
Operating Temperature	-20°C ~ +85°C (-4°F ~ +185°F)
Storage Temperature	-40°C ~ +125°C (-40°F ~ +257°F)

* Total Output Electric Current Amount of all the I/O Port

Toggles
 Rockers
 Pushbuttons
 Illuminated PB
 Programmable
 Keylocks
 Rotaries
 Slides
 Tactiles
 Tilt
Touch
 Indicators
 Accessories
 Supplement

Controller Board for RS232C

FTCS04C

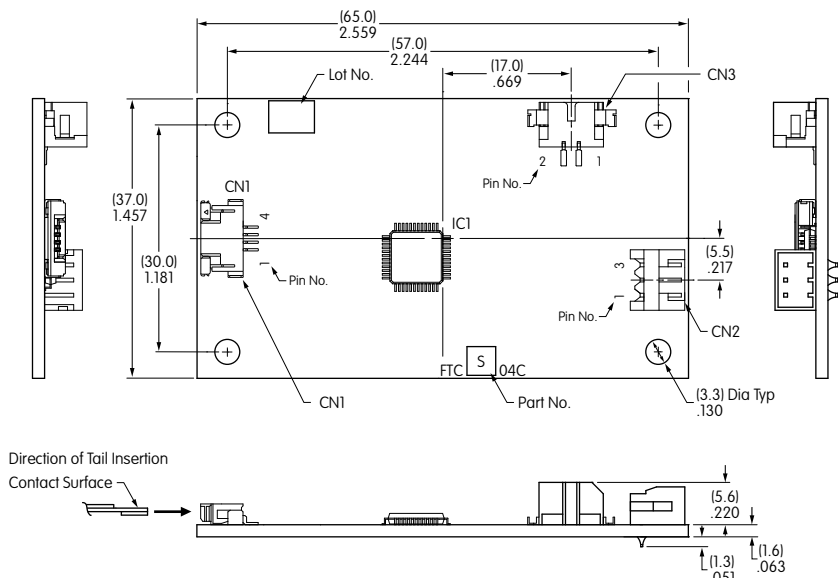

CN1 4-Wire Analog Touch Screen Connector - 4 Pins

Pin No.	Symbol	Description
1	Y0	For Y _{UP} or Y _{LO}
2	Y1	
3	X0	For X _{R1} or X _{LE}
4	X1	

CN2 RS232C Header Connector - 3 Pins

Controller Board Side			
Pin No.	Symbol	Description	Computer Side
1	RD	Receiving Data (IN)	Sending Data
2	SD	Sending Data (OUT)	Receiving Data
3	GND	GND	GND

CN3 Header Connector for Power Supply - 2 Pins

Pin No.	Symbol	Description
1	V _{CC}	Supply Voltage
2	GND	GND

Controller Board for USB

FTCU04C

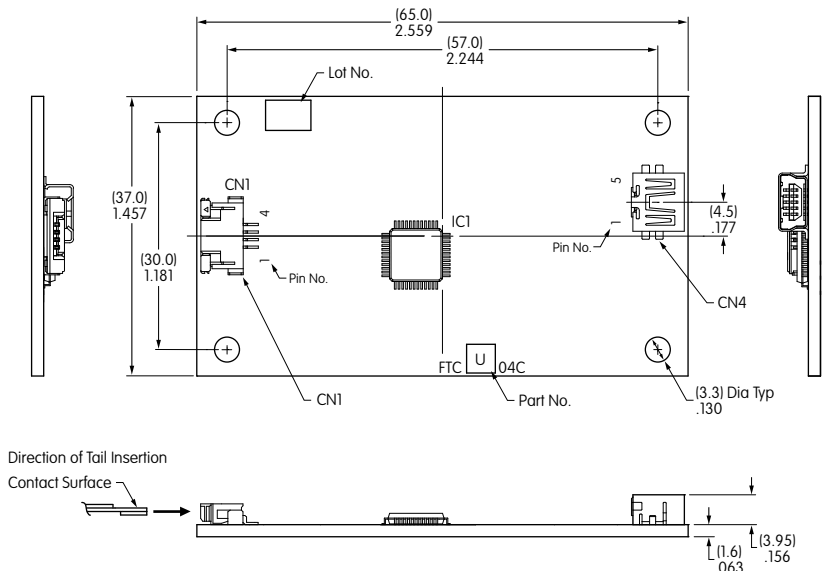

CN1 4-Wire Analog Touch Screen Connector - 4 Pins

Pin No.	Symbol	Description
1	Y0	For Y _{UP} or Y _{LO}
2	Y1	
3	X0	For X _{R1} or X _{LE}
4	X1	

CN4 Header Connector for USB - 5 Pins

Pin No.	Symbol	Description
1	V _{CC}	USB V _{CC}
2	D-	USB D-
3	D+	USB D+
4	GND	USB GND
5	GND	Shield GND

STORAGE, HANDLING & INSTALLATION

Handling of Controller Board

- Use arc prevention to protect device from static electricity.
- Power source should be activated after host and touch panel are connected.
- When inserting connector CN1 and touch panel tail, be sure the slider of connector CN1 is pulled. Do not pull more than 10 times.
- Do not alter the product.
- Do not use any commands other than the ones outlined in the specifications.
- Place the product away from noise source (such as inverter from LCD operation) since tail can be affected by noise.
- If device driver (USB) does not work after installation, reboot the host computer while connected to the controller board.
- This product does not support suspended mode (USB).
- Protocol of USB transmission is one frame per one transaction.
- Contact factory if not using the protocol above
- Warranty for one year after delivery. NKK warranties the 4-wire touch panel when it is used with the NKK control board and driver. Do not use third party control boards. NKK is not responsible for results of using damaged equipment with the controller boards.
- NKK Switches cannot assume responsibility for damages caused by software side during use of the touch screens.

Installation

- Products are ESD sensitive and ESD protection is required.
- Do not pull on the tail. Do not apply stress to the tail area.
- Avoid vibration or shock.
- The touch screen mounting should not be loose. This may cause an adverse effect on detecting performance during operation.
- Ensure there are no burrs around the edges of the case or housing that can cause false actuation. The edges of the case or housing should not enter the keying area.

STORAGE, HANDLING & INSTALLATION

Installation (Continued)

- The case or housing and upper electrode should have a space of about 0.5 mm to accommodate expansion or shrinkage due to temperature variances. If a shock barrier is used, do not press hard on the upper electrode area. Any shock barrier should be installed more than 0.6 mm away from A.
- To secure the touch screen, secure the lower portion with a device such as the LCD display panel. Do not attach the upper electrode with double-sided tape or similar product to avoid stress that can damage the upper or lower electrode.
- In order to balance upper and lower pressure, an air vent may be installed. Ensure that no liquid or oil will enter into the device.
- Moisture from condensation on tail connection or edges may result in migration, causing short circuit failure.

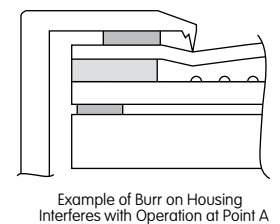
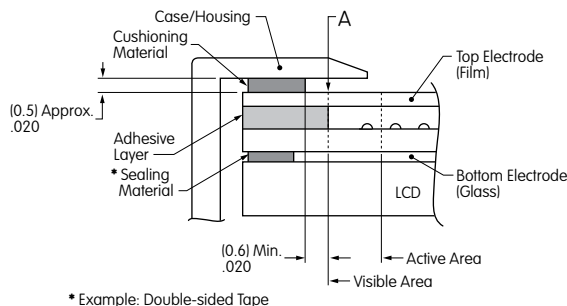

Handling Precautions

- When opening product, take precaution with up/down and front/back directions. Glass edges are not chamfered, and corners or edges can be sharp. Wear gloves when handling the product.
- Do not pick up the product by the tail or pull the tail area.
- Use gloves or finger cots to prevent fingerprints on surface.
- When handling the product, hold it outside of the viewing area.
- Avoid stacking multiple products or placing other items on the product.
- Remove protective film after installation is completed.

Operating Precautions

- Operate with fingers or a touch screen stylus only.
- Do not press hard with a pen or similar object between viewing area and key area.

Design Precautions

- With analog type, resistive value change (by aging or individual differences) can dislocate the input area. Input area can be calibrated with software.
- When installing on top of an LCD, noise from the display device can create misoperation. To avoid noise, implement actions such as grounding the display device frame.
- Do not create software for simultaneous touch points, as analog type will read the center point between two touch points.
- When used to draw a line, analog type will have a break at dot spacer. Compensate for this with software.
- Contact resistance may cause chatter depending on pressing condition. Software should detect signal after it stabilizes.

Other Precautions

- Clean with a soft cloth and ethanol. Do not use any cleaning agents other than ethanol.
- Store product in original package and store at the temperature and humidity range specified.
- Do not store in an environment with acids or other corrosive gases or where condensation may occur.
- Not suited for use in critical control systems without proper fail-safe design consideration.
- Products are guaranteed based on evaluation of standards within the moisture tolerance and usage temperature range, but not guaranteed to operate perpetually at this temperature.
- Note that an incorrect type of connector may damage the print surface.
- Calibration data from one touch panel should not be applied to another panel; each should be calibrated individually.
- Recalibration is necessary if connector has been removed from the tail and reconnected.
- All specifications based on the tested touch screens only. Evaluate the products after installation with customer's equipment.

ANALOG TOUCH SCREENS

1. The analog touch screen has a two-layer structure consisting of polyester film with an ITO membrane and sheet of glass. The surfaces of top and bottom electrodes have a uniform resistive film. One electrode draws in the X-axis direction, the other on the Y-axis direction. When pressure is applied, it changes the resistance value change between X1 and X2 and Y1 and Y2, then converts to a digital signal.

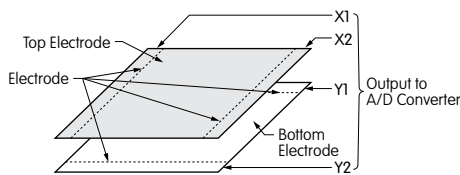

2. To interpret the touched position, 5V is applied to the top electrode (X1 and X2). Then the voltage on the arrow direction evenly changes.

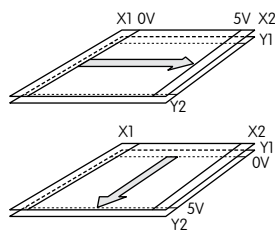

3. With a touch to the center of the top electrode film, the touched position contacts the bottom film (glass), and 2.5V is output to Y1 (or Y2). The output signal is then converted to a digital signal and can be recognized as an X-axis coordinate value. In the same way, the Y-axis

coordinate value can be read from Y1 and Y2 on the bottom electrode. Then the position where the X and Y axis coordinate value intersected is read as the contact position.

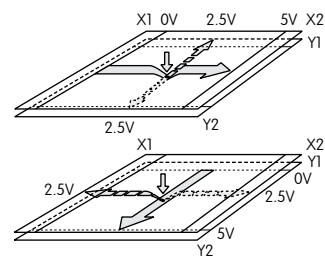

4. The resolution of the analog touch screens is relatively higher than the digital models and contributes to the variety of the screen designs available, including those displaying buttons. Since analog types generally detect signals as a point but not as a number on the keys, the signals may be input as text or drawings with a pen. The vertical and horizontal resolution (detection points) is 1,024 when a 10bit A/D converter is used.

The active area of each button is independent of each other, resulting in no interference between the areas.

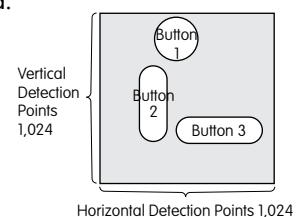

Digital Touch Screen						
Part Number	Screen Size in Inches	Key Area Dimensions	Viewing Area Dimensions	External Dimensions	Panel Thickness	Terminal Detail 30 Pin .039" (1.0mm) Pitch
FTAS225-57AN	5.7	4.54" x 3.39" (115.2mm x 86.04mm)	4.80" x 3.62" (122.0mm x 92.0mm)	5.51" x 4.45" (140.0mm x 113.0mm)	.083" (2.1mm)	Length 3.94" (100.0mm)

Notes: Input method is finger. Number of keys for Digital Touch Screen: 15 x 15. See web site for dimensioned drawings for the Digital Touch Screen.

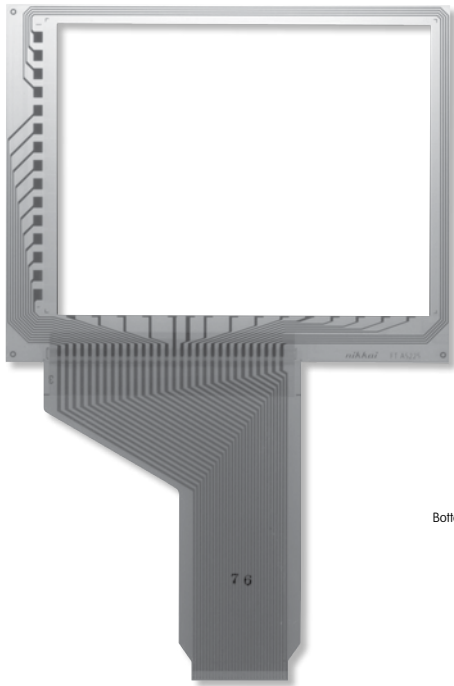

**Digital
FTAS225-57AN**

