

# Broadcasting Pro Audio

Reliable and Streamlined Switching Solutions

**nkk**  
SWITCHES

[www.nkk.com](http://www.nkk.com)

## Product Overview

	Special Features	Outer Dimensions	Basic Specifications
OLED Rocker	<ul style="list-style-type: none"> <li>OLED Rocker Switch, SP3T Momentary</li> <li>IP64 Dust &amp; Water Protection</li> <li>Controller on Board/SPI</li> <li>Largest SmartSwitch Display Area</li> <li>180° Viewing Angle</li> <li>Up to 8 Lines with 16 Characters Each</li> </ul>	<b>Rocker:</b> 37.9 x 50.7 x 5.6mm	Display Luminance Half-life: 52,000 hrs. @ 100cd/m <sup>2</sup> with 30% pixels on  Operating Temperature: -20°C to +70°C  Mechanical/Electrical Life: 1,000,000 actuations min.
OLED Pushbutton	<ul style="list-style-type: none"> <li>Display Videos</li> <li>65K Colors</li> <li>Sharp Display of Small Text/Graphics</li> <li>180° Viewing Angle</li> <li>Controller on Board/SPI</li> <li>Best Contrast in the Market</li> <li>Up to 6 Lines with 10 Characters Each</li> </ul>	<b>Pushbutton:</b> 23.13 x 20.59 x 23mm  <b>Display:</b> 17.8 x 17.2 x 9.9mm	Display Luminance Half-life: 60,000 hrs. @ 50cd/m <sup>2</sup> with 40% pixels on 30,000 hrs. @ 100cd/m <sup>2</sup> with 40% pixels on  Operating Temperature: -20°C to +70°C  Mechanical/Electrical Life: 3,000,000 actuations min.
LCD 64 x 32	<ul style="list-style-type: none"> <li>RGB LED Backlight, 64 Colors               <ul style="list-style-type: none"> <li>Controlled via Software</li> </ul> </li> <li>Controller on Board/SPI</li> <li>Long Life LCD</li> <li>Up to 4 Lines with 10 Characters Each</li> </ul>	<b>Pushbutton:</b> 23.13 x 20.59 x 23mm  <b>Compact Pushbutton:</b> 19 x 18 x 23mm  <b>Display:</b> 17.8 x 17.2 x 9.9mm	Operating Temperature: -15°C to +50°C (-20°C to +60°C available)  Mechanical/Electrical Life: 3,000,000 operations min. 1,000,000 actuations min. For Compact
LCD 36 x 24	<ul style="list-style-type: none"> <li>Bicolor or RGB Backlight</li> <li>LCD Driver on Board</li> <li>Long Life LCD</li> <li>Flexible Control of Backlight and LCD</li> <li>Up to 3 Lines with 6 Characters Each</li> </ul>	<b>Pushbutton:</b> 23.13 x 20.59 x 23mm  <b>Compact Pushbutton:</b> 19 x 18 x 23mm  <b>Display:</b> 17.8 x 17.2 x 9.9mm	Operating Temperature: 0°C to +40°C (-20°C to +60°C available)  Mechanical/Electrical Life: 1,000,000 actuations min.

All Pushbutton Versions: SPST, Momentary ON, Gold Contacts and Straight PC Terminals.

Visit [www.nkksmartswitch.com](http://www.nkksmartswitch.com) for complete specifications.

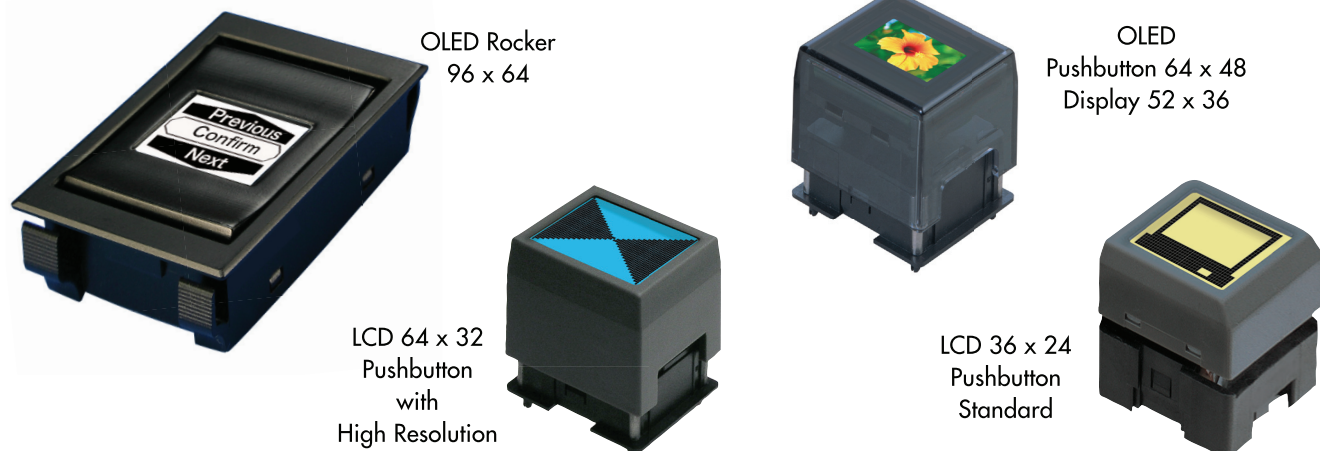



## OLED Rocker

- All-in-one solution: rocker switch with integrated pushbutton & display
- Scroll up & down with rocker to select, push for activation
- Monochrome long life display
- IP64 dust protected & splashproof (water spray from any direction on panel)
- Snap-in mount
- Compatible with 3D glasses

OLED Monochrome Rocker  
96 x 64 Pixels

IS18WWC1W

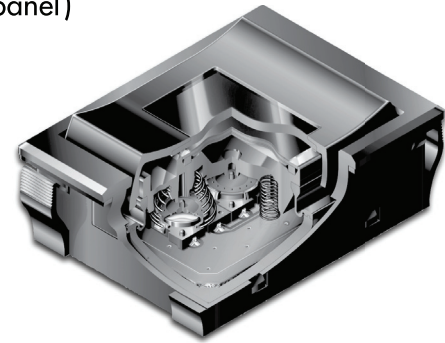

## OLED Pushbutton & Display

- Display videos at 100+ frames per second
- Sharp display of small characters/graphics
- Low power consumption of only 3.8mA
- Compatible with 3D glasses
- 65K colors
- Controller on board
- Stylish design
- Dust protected

## OLED Advantages

Fast response - run video  
High resolution  
Exceptional contrast  
Sharp image from all viewing angles  
Wide temperature range



Actual Size



OLED Pushbutton  
64RGB x 48 Pixels

ISC15ANP4



OLED Display  
52RGB x 36 Pixels

ISC01P

## Expanded Viewing Area Features & Specifications

### LCD 64 x 32 Pushbutton with High Resolution

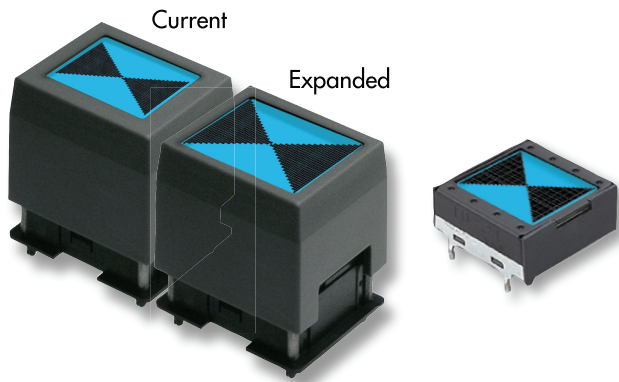

Viewing Areas  
 Pushbutton: 0.8" Display: 0.7"

### Viewing Area Comparisons

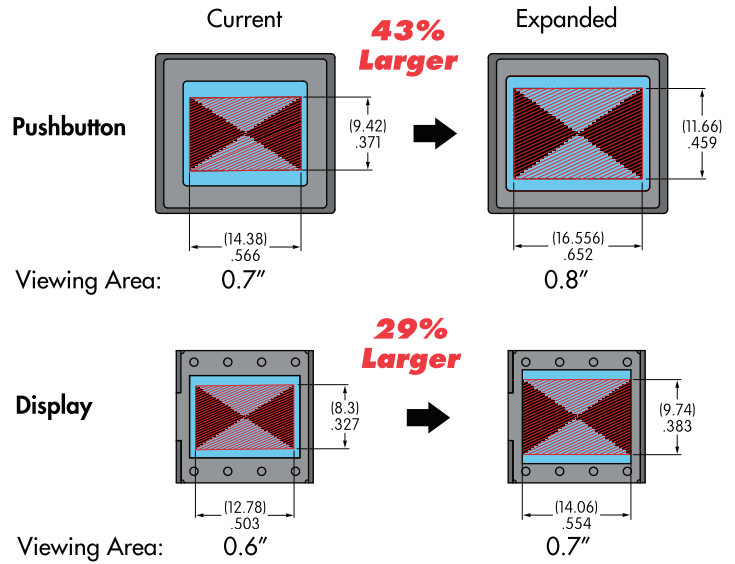

### LCD 64 x 32 Compact Pushbutton with High Resolution

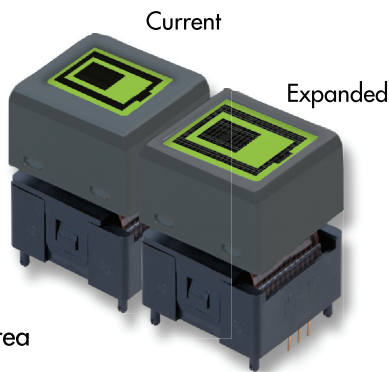

Viewing Area  
 Pushbutton: 0.7"

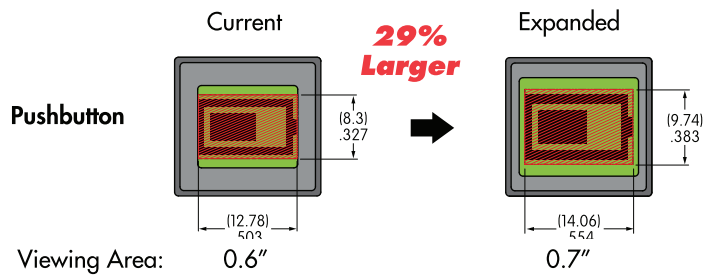

### LCD 36 x 24 Pushbutton Standard

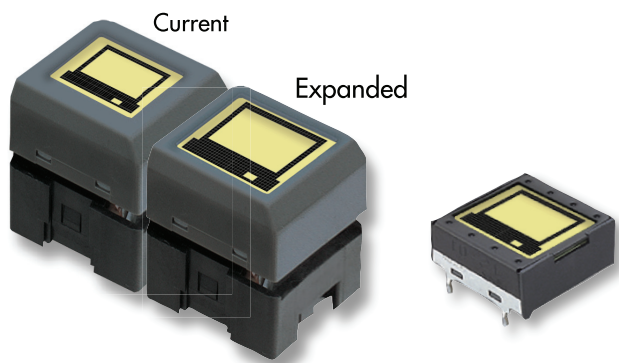

Viewing Areas  
 Pushbutton: 0.8" Display: 0.7"

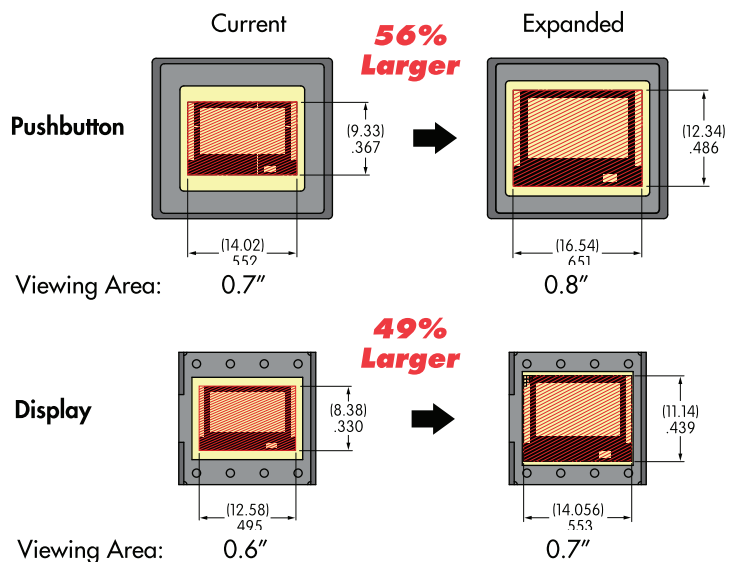

## LCD 64 x 32 Pushbutton & Display

- 2 sizes of pushbuttons, compact switch is 28% smaller
- Software control for backlighting
- 64 color backlighting
- Up to 4 lines with 10 characters each
- Graphic display capable of alphanumeric characters & animations
- Low energy consumption
- Dust protected
- Compatible with 3D glasses (add -3D to part number for LCD Pushbutton)

**LCD 64 X 32 FSTN  
Compact Pushbutton with  
Standard Size Cap and  
Tactile Feel**



Custom  
IS15DBFP4RGB  
(Tactile Feel)

## LCD 36 x 24 Pushbuttons & Displays

- 2 sizes of pushbuttons, compact switch is 28% smaller
- Graphic display capable of alphanumeric characters & animations
- Full control of backlight
- Bicolor, and RGB backlighting
- Most economical SmartSwitch
- Up to 3 lines with 6 characters each
- Compatible with 3D glasses (add -3D to part number for LCD Pushbuttons)

### TYPICAL SWITCH ORDERING EXAMPLE

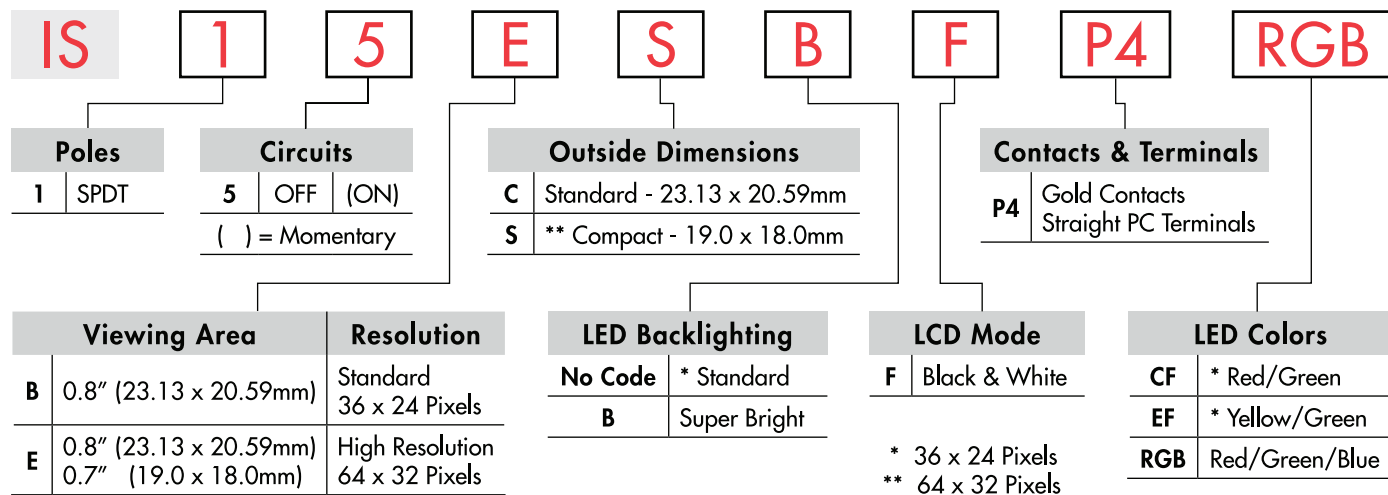

### TYPICAL DISPLAY ORDERING EXAMPLE

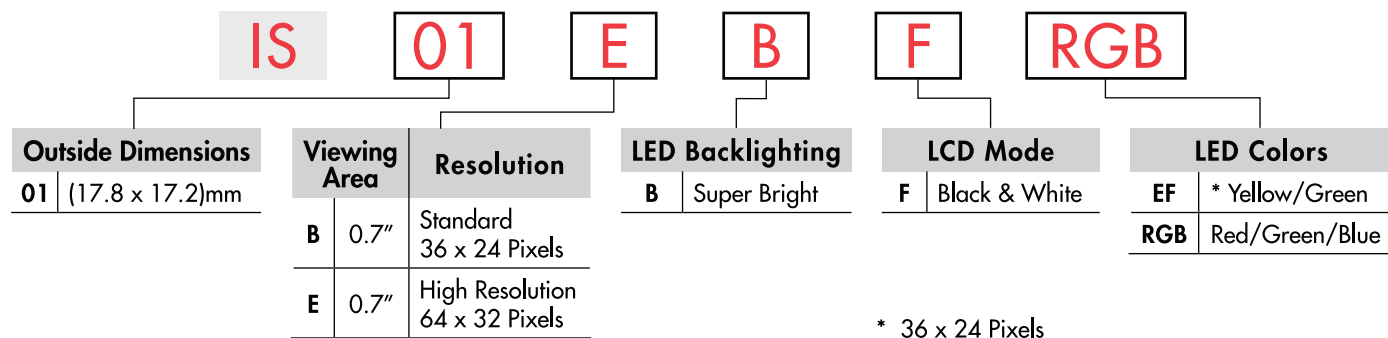

# Broadcasting / Pro Audio

## Illuminated Pushbutton Solutions



### KP Pushbuttons with RGB LEDs for Unlimited Vibrant Colors

3 button sizes and shapes including home key; all buttons clear with white insert for elegant panel design; create any desired color with RGB LEDs  
Alternating red/green and blue/amber legends are also available.



### 14mm KB Pushbuttons

Square, round, rectangular  
many illumination and  
button color options



### YB2 Flush Mount Pushbuttons

6 LED color options for full face or  
silver button with ring illumination  
or nonilluminated including silver button

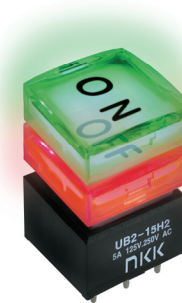

### UB2 Pushbuttons

3 button shapes; 7 LED color  
options including alternating  
red/green and blue/amber  
legends



### 9mm HB Pushbuttons

Square or round; many illumina-  
tion and button color options



### 7.5mm HB2 Pushbuttons

Our smallest square  
illuminated pushbutton



### 12mm NP01 Soft Touch Pushbuttons

4 LED color options including  
alternating red/green  
and blue/amber legends  
or nonilluminated



# Broadcasting / Pro Audio

## More Audio Switch Solutions

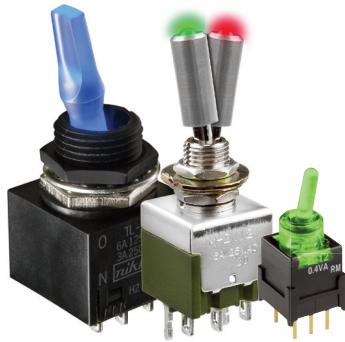

**Eye Catching Toggles**  
TL, M2100 and B series (from left)  
with full toggle or tip illumination



**Miniature Power Level Rotaries**  
MR Rotaries with adjustable positions  
Use NKK's or your own knobs  
to match existing design



**Submini Toggles & Pushbuttons**  
G and GB Series; used in microphones  
and other handheld devices



**Rockers & Paddles**  
Wide variety of rockers or paddles  
make the MLW pop on any panel



**PCB Rotaries**  
Perfect PCB solutions



**Tactiles for Board Design**  
Up to 5 million operations; wide  
range of buttons; illuminated or  
nonilluminated



**LED or Neon Rockers**  
Small ON-OFF switches

## New Bicolor Alternating Legends

Four series share new super bright blue/amber bicolor

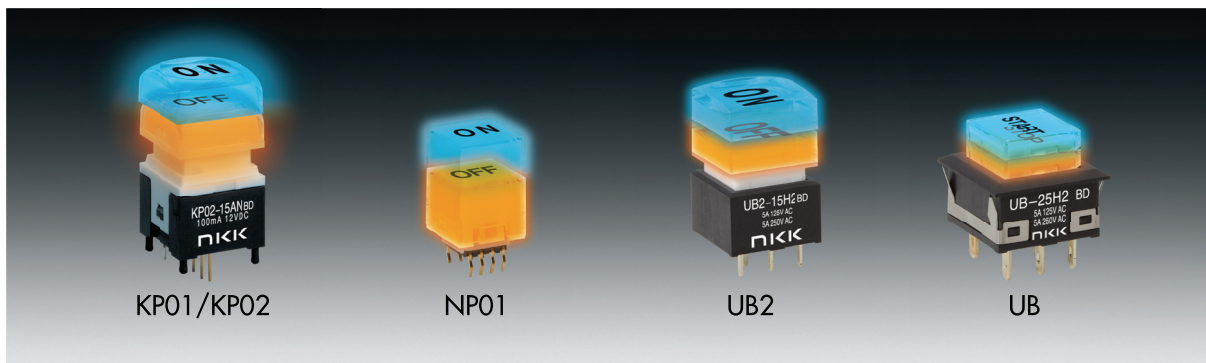



Broadcast Switcher with  
OLED and LCD Pushbuttons

# NKK SWITCHES

**NKK Switches Co., Ltd.**

<http://www.nkk.com> E-mail: [contact@nkkswitches.eu](mailto:contact@nkkswitches.eu)

## European Liaison Office:

Mergenthalerallee 10-12 , 65760 Eschborn, Germany  
TEL: +49 61 96 400 187 / +49 61 96 400 189 (German)

## Corporate Headquarters:

715-1, Unane, Takatsu-ku, Kawasaki-shi, 213-8553 Japan  
TEL: +81 44 813 8008 FAX: +81 44 813 8038

## Global Offices:

Americas: NKK Switches of America, Inc. (Scottsdale, AZ, USA)  
Asia: NKK Switches Hong Kong Co., Ltd. (Hong Kong, PR China)  
China: NKK Switches China. Co., Ltd. (Shanghai, PR China)

**NKK**  
SWITCHES